

Book of Abstracts

Sustain 2017

For updated programs and locations
see www.sustain.dtu.dk



Table of contents

- Sponsors
- Alphabetic overview of Sessions A-X
Talks, Laptop and Poster presentations

For updated programs and locations
please see www.sustain.dtu.dk



Sponsors 2017



Session

A

Oral Presentations

See session details and schedule on
www.sustain.dtu.dk



Effects of global warming and pollutants on marine copepods across space and time

Khuong Van Dinh^{*,1}, Torkel Gissel Nielsen¹

1: DTU-Aqua, Technical University of Denmark

*Corresponding author email: kvdi@aquu.dtu.dk

Global warming and pollution are two major threats to global biodiversity, but it remains relatively unknown how these stressors interact synergistically on marine copepods across space and time. We addressed this through: (i) investigation of vulnerability of marine copepods from arctic to tropical ecosystems to global warming, heat waves and pollution and (ii) incorporating the evolution of thermal adaptation in shaping the vulnerability of marine copepods to contaminants. First of all, we investigated the combined effects of global warming and contaminants (e.g. polycyclic aromatic hydrocarbons - PAHs) on both thermal generalist and specialist copepods from arctic to tropical ecosystems (Greenland, Norway, Denmark and Vietnam) in order to generate a comprehensive understanding of their vulnerability to different scenarios of stressor levels. To fundamentally advance the mechanistic understanding of the role of thermal adaptation, we are exposing a fast growing tropical copepod to a simulated scenario of global warming for 10, 50 and 100+ generations and tracking the fitness-related traits in relating to the changes in physiology (e.g. respiration, heat shock proteins) and the gut microbiomes. We found that global warming had stronger negative effects on highly thermally adapted copepods such as arctic species while wide distribution species e.g. *Acartia tonsa* can deal well with the temperature increase. Exposure to PAH pyrene at the concentration of 100 nM or higher resulted in higher mortality, reduced fecal pellet and egg production of copepods; this pattern was less strong in arctic copepod such as *Calanus glacialis* than other copepods species. Our studies emphasizes the need to put more effort on studying key species such as marine copepods in highly thermally extreme environments like the Arctic and tropical marine ecosystems.



Female copepod *Calanus finmarchicus* (photo credit: Khuong V. Dinh)

Will salinity hinder the ongoing northward dispersal of the invasive round goby into the oceanic North Sea?

Jane Behrens¹, Mikael van Deurs¹ og Emil A. F. Christensen¹

1: National Institute of Aquatic Resources, Technical University of Denmark, Kemitorvet B-202. 2800 Kgs Lyngby Denmark

*Corresponding author email: jabeh@aqua.dtu.dk

Non-indigenous species (NIS) can impact marine biodiversity and ecosystem structure and function. Once introduced into a new region, secondary dispersal is limited by the physiology of the organism in relation to the ambient environment and by complex interactions between a suite of ecological factors such as presence of predators, competitors, and parasites. Early prediction of dispersal potential and future 'area of impact' is challenging, but also a great asset in taking appropriate management actions. Aerobic scope (AS) in fish has been linked to various fitness-related parameters, and may be valuable in determining dispersal potential of aquatic invasive species in novel environments.

Round goby *Neogobius melanostomus*, one of the most wide-ranging invasive fish species in Europe and North America, currently thrives in brackish and fresh water, but its ability to survive in high salinity waters is unknown to date. We show that AS in round goby is reduced by 30% and blood plasma osmolality increased (indicating reduced capacity for osmoregulation) at salinities approaching oceanic conditions, following slow ramping (5 PSU per week) and subsequent long-term acclimation to salinities ranging between 0 and 30

PSU (8 days at final treatment salinities before blood plasma osmolality measurements, 12±20 additional days before respirometry). Survival was also reduced at the highest salinities yet a significant proportion (61%) of the fish survived at 30 PSU. Reduced physiological performance at the highest salinities may affect growth and competitive ability under oceanic conditions, but to what extent reduced AS and osmoregulatory capacity will slow the current 30 km year⁻¹ rate of advance of the species through the steep salinity gradient from the brackish Baltic Sea and into the oceanic North Sea remains speculative.

An unintended natural experiment is in progress to test whether the rate of advance slows down. At the current rate of advance the species will reach the oceanic North Sea by 2019/2020, therefore time for taking preventative action is short.



Round goby *Neogobius melanostomus*
Photo: Peter van der Sluijs

Spatial distribution, origin and source and sink areas of marine litter in the water column of the North Sea

Bastian Huwer*¹, Matthias Kloppmann², Christophe Loots³, Cindy van Damme⁴, Richard Nash⁵, Barbara Bland⁶, Lynette Ritchie⁷

1: DTU Aqua, National Institute of Aquatic Resources, Kgs. Lyngby, Denmark; 2: Thuenen Institute of Sea Fisheries, Hamburg, Germany; 3: IFREMER, Boulogne-sur-mer, France; 4: Wageningen Marine Research, IJmuiden, The Netherlands; 5: Institute of Marine Research, Bergen, Norway; 6: SLU, Havs fiskelaboratoriet, Lysekil, Sweden; 7: Marine Scotland, Aberdeen, Scotland

*Corresponding author email: bhu@aqu.dtu.dk

Marine litter, in particular plastic, is becoming an increasing issue in marine ecosystems worldwide. Most marine litter studies are based on surface sampling, beach or bottom trawl surveys, whereas information on marine litter in the water column is rather scarce. In the present study, we utilize an existing herring larvae survey, intended to produce a recruitment index used in fish stock assessment, for opportunistic sampling of marine litter. The survey is covering the entire North Sea and the sampling gear is covering the water column from the surface to 3 meter above the sea floor, providing a unique opportunity to analyze the spatial distribution of different types of marine litter floating in the water column. The characteristics of the litter items such as size, shape and color give indications from which sea- or land-based sources they may originate. The vast majority of collected litter items are different types of plastic materials, and of these the most abundant types are monofilaments, foils, fragments and synthetic rope. The monofilament plastic strings are likely originating from fishing activities, in particular from so-called “dolly ropes”. These “dolly ropes”, short pieces of synthetic rope, are attached to the cod ends of fishing nets to protect them from wear and tear, a practice that is particularly common in beam trawl fisheries. The spatial distribution of these plastic strings shows distinct, annually recurring patterns, which in connection with information from beach surveys, spatial patterns of fishing activity and prevailing currents indicate the existence of source and sink areas of marine litter in the North Sea. There are several negative effects of marine litter, e.g. reduced attractiveness of polluted beaches which may influence tourism, entanglement of marine mammals and seabirds in lost fishing nets and other litter items or the ingestion of litter by marine species which potentially results in constipation and death. A particular issue concerning “dolly ropes” is the fact that sea birds are mistaking these plastic threads for sea weed and use them to build their nests, which can cause them to get entangled and strangled.

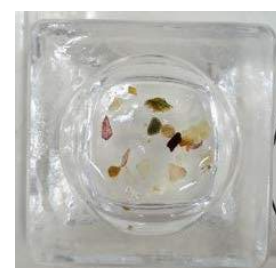
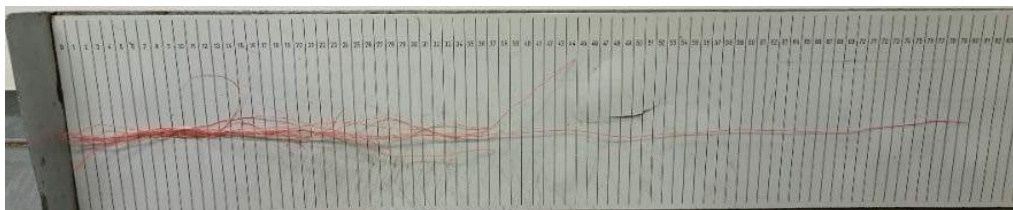

Circular Ocean. Environmental challenges related to waste fishing nets and innovative use as resource in fiber-reinforced concrete

Lisbeth M. Ottosen*¹, Ida M.G. Bertelsen¹, Martin Charter², Neil James³

1: DTU Civil Engineering, Brovej, Building 118, Technical University of Denmark, 2800 Kgs. Lyngby

*Corresponding author email: lo@byg.dtu.dk

2: The Centre for Sustainable Design, University for the Creative Arts, UK

3: Environmental Research institute. North Highland College UHI (Scotland)

Marine plastic litter is a growing concern, and one particular troublesome marine waste fraction is discarded fishing gear. Increasing levels of marine litter is particularly pertinent to the Northern Periphery and Arctic region. The EU funded project Circular Ocean focuses on identifying possible use of the waste fishing nets in this region by acting as a catalyst to motivate and empower remote communities to develop sustainable and green business opportunities based of waste fishing nets as resource. A recent Circular Ocean report [1] based on unpublished national port-related feasibility studies focused on the collection and recycling of waste fishing nets and ropes. Among others, it was found that there is a very fragmented picture of the issues surrounding waste fishing nets and ropes in the region with little research completed to date. Additionally, there appears to be a lack of clear innovation eco-systems within port areas to enable the development of eco-innovative products from waste fishing nets and ropes.

To support increased use of the waste fishing nets, mechanical properties of PE and Nylon 6 waste fishing nets have been documented at DTU Byg. On basis of the findings different uses of these fibers in concrete have been suggested and experimentally investigated. The result is that PE can be used for increased durability by control of plastic shrinkage cracking, whereas Nylon 6 can be used for structural purposes, i.e. improvement of mechanical properties such as ductility (yet unpublished results).



Fig. 1: Waste fishing nets at dumpsite in Greenland - a resource as fibers to reinforce concrete?

Acknowledgement. The project is funded by the EU Northern Periphery and Arctic Programme (NPA).

References

[1] Charter, M. (2017) summary of the findings of port-related feasibility studies related to the collection and recycling of waste fishing nets and ropes in Greenland, Ireland, Norway and Scotland.

<http://www.circularocean.eu/wp-content/uploads/2017/11/Circular-Ocean-Port-Reports-FINAL.pdf>

Preliminary results: Deep sea oil spill in the Arctic – effects of pyrene on overwintering *Calanus copepods*

Kirstine Toxværd^{1,2}, Khuong Van Dihn², Morten Hjorth², Torkel Gissel Nielsen^{*2}

1: COWI, Department of Water & Nature, Parallelsvej 2, 2800 Kgs Lynby, 2: National Institute of Aquatic Resources, Technical University of Denmark, Kemitorvet Building 201, 2800 Kgs Lyngby, Denmark

*Corresponding author email: tgin@aqua.dtu.dk

Polar Oceans are some of the least impacted by human activities due to seasonal or permanent sea ice that limits human access. Projections of future polar ice loss suggest that the impact will increase substantially because of changing environmental conditions and pollution. Arctic Oceans hold a substantial amount of the world's remaining oil and gas reserves, but exploration is extremely technically challenging. To enable proper



Picture: *Calanus hyperboreus* after long-term exposure to pyrene. Credits: Kirstine Toxværd

risk assessment, it is crucial to understand how oil spills can impact Arctic marine ecosystems. During polar night, biological processes in Arctic marine ecosystems are conventionally believed to slow down or cease. Indeed, several marine species have overwintering strategies, such as the *Calanus* copepods that overwinter for 8-10 months at depths of 200-2000 m and migrate to the productive surface layers to feed on the short Arctic bloom.

We conducted a winter experiment with two species of Arctic copepod to study the impact of long term exposure to oil during polar night. We used the ecologically important *Calanus hyperboreus* (winter breeder) and *C. glacialis* (spring breeder) as test species, and quantified effects on the fitness-related traits mortality, egg production, grazing and egg hatching. Females were incubated in bottles with seawater and the oil compound pyrene (in concentrations of 0.1, 1, 10, 100 and 100+ nM) from December to March. They were transferred to clean seawater and fed in excess for 2-3 weeks until termination of the experiment. Mortality was checked daily, and egg and fecal pellets were collected within 24 h of production. Egg hatching success was determined at the beginning, middle and end of the experiment. Preliminary results indicate that *C. hyperboreus* exhibit a delayed response to pyrene through reduced feeding after transfer to clean seawater. Effects diminish over time, and feeding rate is recovered after 14 days without exposure to oil. Both egg production and feeding rate of *C. glacialis* is impacted by exposure in a concentration dependent manner after transfer to clean seawater. These findings suggest, that long term oil exposure during overwintering does indeed impact both *Calanus* species, and that *C. hyperboreus* seem to be more robust than the smaller *C. glacialis*. While effects on *C. glacialis* may have implications for stock recruitment within the season, potential effects on *C. hyperboreus* are likely delayed until next season. Negative effects on copepods may potentially affect the entire food chain and have severe ecosystem effects.

Session

A

Poster Presentations

See session details and schedule on
www.sustain.dtu.dk



No increase in marine microplastic concentration over the last three decades – A case study from the Baltic Sea

Sabrina Beer^{*1,2}, Anders Garm², Bastian Huwer¹, Jan Dierking³, Torkel Gissel Nielsen¹

1: DTU Aqua - National Institute of Aquatic Resources, Technical University of Denmark, Kgs. Lyngby, Denmark; 2: Marine Biological Section, University of Copenhagen, Denmark; 3: GEOMAR Helmholtz Centre for Ocean Research, Kiel, Germany

*Corresponding author email: sabrinabeer@hotmail.com

Microplastic is considered a potential threat to marine life as it is ingested by a wide variety of species. Most studies on microplastic ingestion are short-term investigations and little is currently known about how this potential threat has developed over the last decades where global plastic production has increased exponentially. Here we present the first long-term study on microplastic in the marine environment, covering three decades from 1987 to 2015, based on a unique sample set originally collected and conserved for foodweb studies. We investigated the microplastic concentration in plankton samples and in digestive tracts of two economically and ecologically important planktivorous forage fish species, Atlantic herring (*Clupea harengus*) and European sprat (*Sprattus sprattus*), in the Baltic Sea, an ecosystem which is under high anthropogenic pressure and has undergone considerable changes over the past decades. Surprisingly, neither the concentration of microplastic in the plankton samples nor in the digestive tracts changed significantly over the investigated time period. Average microplastic concentration in the plankton samples was 0.21 ± 0.15 particles m^{-3} of filtered seawater. Of 814 fish examined, 20% contained plastic particles, of which 95 % were characterized as microplastic (<5 mm) and of these 93% were fibers. There were no significant differences in the plastic content between species, sampling locations, or time of day the fish were caught. However, fish size and microplastic particles in the digestive tracts were positively correlated, and the fish contained more plastic during summer than during spring, which may be explained by increased food uptake with size and seasonal differences in feeding activity. This study highlights that even though microplastic has been present in the Baltic environment and the digestive tracts of fishes for decades, the levels have not changed in this period. This underscores the need for greater understanding of how plastic is cycled through marine ecosystems. The stability of plastic concentration and contamination over time observed here indicate that the type and level of microplastic pollution may be more closely correlated to specific human activities in a region than to global plastic production and utilization as such.

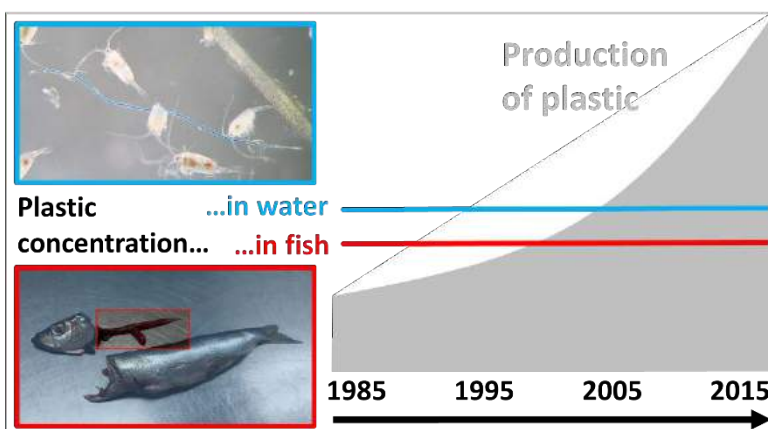

Reference:

Beer S, Garm A, Huwer B, Dierking J, Nielsen TG. No increase in marine microplastic concentration over the last three decades – A case study from the Baltic Sea.

Science of the Total Environment (2017)
<https://doi.org/10.1016/j.scitotenv.2017.10.101>



Ecological effects of scrubber water discharge on coastal plankton: Potential synergistic effects of contaminants reduce survival and feeding of the copepod *Acartia tonsa*

*Marja Koski, Colin Stedmon, Stefan Trapp

*Corresponding author email: mak@aqua.dtu.dk

To meet the oncoming requirements for lower sulphur emissions, shipping companies can install scrubbers where the exhaust is sprayed with seawater and subsequently discharged to the sea. The discharge water has a pH around 3 and contains elevated concentrations of vanadium, nickel, lead and hydrocarbons. We investigated 1) the threshold concentrations and exposure times of scrubber discharge water for survival, feeding and reproduction of the copepod *Acartia tonsa*, 2) whether the effects depend on the exposure route and 3) whether exposure to discharge water can be detected in field-collected organisms. A direct exposure to discharge water increased adult copepod mortality and reduced feeding at metal concentrations which were orders of magnitude lower than the lethal concentrations in previous single-metal studies. In contrast, reproduction was not influenced by dietary uptake of contaminants. Scrubber water constituents could have synergistic effects on plankton productivity and bioaccumulation of metals, although the effects will depend on their dilution in the marine environment.

Acute and semi-chronic toxicity of vanadium

tested on copepods of the species Temora longicornis

Authors: [Kristiansen, M. H.¹](#), [Iversen, N. H.²](#), [Koski³, M.](#), [Trapp, S.⁴](#)

Affiliations: **DTU Aqua** National Institute of Aquatic Resources and **²DTU Environment** Department of Environmental engineering

Corresponding author email: mak@aqu.dtu.dk³ and sttr@env.dtu.dk⁴

Objectives: This study examines the toxicity and ecological impact of scrubber water on plankton, through acute and chronic toxicity tests, with primarily vanadium. Tests with pH and scrubber water have also been carried out. The study's goal was to: I) find the LC50 of vanadium (single stressor), II) examine how the toxicity of vanadium and scrubber water may change with varying pH (double stressor), III) devise an ecotoxicological assessment on scrubber water handling and disposal (based on empirical data and test results), and IV) to determine the marine environmental impacts scrubber water discharge into the sea may have.

Background: Marine scrubber-systems on ships are on the rise, which leads to concerns regarding safe handling of the waste products, namely scrubber water. The most common way of discarding scrubber water is through discharge into the sea where it disperses and dilutes to concentrations that are considered safe. However, in heavily trafficked zones with slow water flow, discharge of scrubber water may happen too frequently potentially resulting in zones with pH fluctuations and higher concentrations of heavy metals. The noticeable heavy metals in scrubber water are nickel, vanadium and lead. While the ecological effects of Ni and Pb have been tested, the effects of V are largely unknown.

Case presentation: This case presents copepods that have been grown in captivity but represent wild copepod populations. They have in several tests been exposed to different concentrations of vanadium and scrubber water, along with varying pH values. The general response found in the acute tests was an increased mortality. For the long exposure chronic test, a change in respiration and reproduction were found. In the first experiment vanadium was found to have a LC50 at a concentration of 1 - 2 mg vanadium / L . A vanadium concentration higher than 4 mg / L were found to increase the mortality rate of copepods to 100% within 24 hours. In the second experiment pH and vanadium was tested together as double stressors. When the pH was 6 or below along with a constant vanadium concentration of 1 mg / L, 100% mortality of copepods was observed. At pH 7 a lower LC50 was found and less mortality was observed with increasing pH to 8 (the pH of seawater) where the mortality was about 10%. The third experiment showed the impact of pure scrubber water diluted with seawater. Mixing ratios of 25%, 50% 75% and 100% scrubber water showed that a 100% mortality was achieved at $\geq 50\%$ scrubber water concentration. At 25% scrubber water concentration a mortality of 80% was observed. The fourth experiment set out to test the toxicity of scrubber water that had been neutralized to the pH of seawater. The samples consisted of 100% scrubber water and pH of 6, 7 and 8. The samples with pH 6 had a 100% mortality and a LC50 was found at pH 7. The samples with pH 8 had a mortality of 20%. The final experiment is a longtime exposure of vanadium (chronic test) at concentrations of 0.1 and 0.5 mg / L (low mortality concentrations). The idea is to measure the respiration along with the reproduction and growth rate over a period of 3 weeks to investigate the sub-lethal effects of a low but chronic exposure to vanadium.

The invasive comb jelly *Mnemiopsis leidyi* in Europe and in the Baltic Sea: Invasion history, distribution, phenology and ecosystem impacts

Bastian Huwer^{1*} and Cornelia Jaspers^{1,2*}

¹DTU Aqua, National Institute of Aquatic Resources, Technical University of Denmark, Charlottenlund, Denmark, ²GEOMAR - Helmholtz Centre for Ocean Research, Kiel, Germany,

*Corresponding author emails: bhu@aqua.dtu.dk, cjaspers@geomar.de

The comb jelly *Mnemiopsis leidyi*, native to the east coast of the Americas, has a long invasion record and is known to affect invaded ecosystems including commercially important fish, either by direct predation on eggs and larvae or by competition for the same prey resources. In the 1980's it was introduced to the Black Sea, where it has contributed to the decline of several fish stocks. Since its introduction to northern Europe in the mid 2000's, DTU AQUA has initiated and participated in a number of studies addressing key questions about its population dynamics, invasion success and feeding preferences. The present poster presents a selection of these, including a reconstruction of the invasion history in western Eurasia based on >12,000 geo-referenced occurrence data, an analysis of secondary dispersal via ocean currents, as well as the seasonal phenology in the main spawning area of Baltic cod and sprat and associated ecosystem impacts. While ballast water releases are believed to be the main vector of primary introductions, our results highlight the importance of ocean currents driving secondary spread dynamics of non-native marine species. The impact of *Mnemiopsis leidyi* on Baltic fish stocks is presently regarded to be negligible due to a lack of overlap between the ctenophore and fish early life stages in time and space as well as low biomass of *M. leidyi* in the relevant areas as a result of reduced reproduction in the low saline central Baltic Sea.



Session

C

Oral Presentations

See session details and schedule on
www.sustain.dtu.dk



Materials for Catalysis, Synthetic Fuels and Chemical Energy Conversion

Khurram Saleem Joya*^{1,2}, Kent Kammer Hansen¹ and Peter Holtapels¹

1: Department of Energy Conversion and Storage, Technical University of Denmark (DTU), Frederiksborgvej 399, 4000 Roskilde, Denmark

2: Department of Chemistry, University of Engineering and Technology, GT Road 54890 Lahore, Pakistan

*Corresponding author email: khsa@dtu.dk, khurramdtu@gmail.com

Functional thin-film nanomaterials are becoming increasingly significant for many important applications in industry, for essential catalytic processes and for solar & chemical energy conversion schemes.[1,2] In this pursuit, developing robust and high activity electrocatalytic materials for water oxidation and CO₂ conversion, and their synergistic interfacing with competent light-harvesting modules is very important to progress the construction of solar to fuel conversion system.[3] We have exploited various functional nanoscale materials for catalytic water splitting, CO₂ reduction, and recently for biomass catalysis and solar energy conversion.[3,4] We implemented several molecular, inorganic nanomaterials and metal-oxides displaying great potential to be used in electrocatalysis. Their effective interfacing with semiconductor photo-responsive materials and/or CO₂ reduction systems can provide a potential scheme to make renewable energy supplies.[5] Further we are also exploring catalysis for biomass conversion into chemicals and synthetic fuels opening new ventures for chemicals and energy conversion.

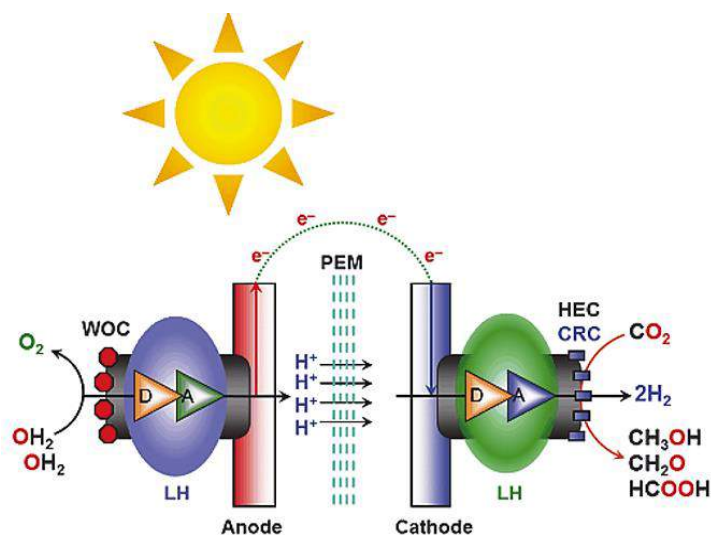

Figure 1. Proposed solar-driven device for catalysis, synthetic fuels and chemical energy conversion.

References

- [1] K. S. Joya, Y. F. Joya, K. Ocakoglu, R. van de Krol, *Angew. Chem. Int. Ed.*, 52 (2013) 10426–10437.
- [2] K. S. Joya, Y. F. Joya, H. J. M. de Groot, *Adv. Energy Mater.*, 4 (2014) 1301929.
- [3] M. de Respinis, K. S. Joya, H. J. M. De Groot, F. D'Souza, W. A. Smith, R. van de Krol, B. Dam, *J. Phys. Chem. C*, 119 (2015) 7275–7281.
- [4] K. S. Joya, H. J. M. de Groot, *ACS Catal.* 6 (2016) 1768–1771.
- [5] K. S. Joya, N.K. Subbaiyan, F. D'Souza, H. J. M. de Groot, *Angew. Chem. Int. Ed.*, 51 (2012) 9601–9605.



Single-Atom Catalysts of Platinum for Electrochemical Reactions: Activity, Selectivity, and Support Effect

Sungeun Yang,^{1,2,*} Ji-Hwan Kim,² Hyunjoo Lee²

1: Department of Physics, Technical University of Denmark (DTU), Kongens Lyngby, Denmark

2: Department of Chemical and Biomolecular Engineering, Korea Advanced Institute of Science and Technology (KAIST), Daejeon, Republic of Korea

*sungya@fysik.dtu.dk

Single-atom catalysts are atomically dispersed metal atoms anchored on the support surface. Single-atom catalysts exhibit intriguing catalytic properties due to its surface structure that active atoms are well separated with each other, and each individual atoms interact with support atoms. Herein, we show different types of Pt single-atom catalysts using different support materials: gold nanoparticles, titanium nitride, titanium carbide, and antimony doped tin oxide. Pt single-atom catalysts exhibited several interesting features in electrochemical reactions. Near hundred percent metal utilization of Pt led to high mass activities in electrochemical reactions. Absence of ensemble site, atomically dispersed active sites, was responsible for controlling the reaction pathways. Support effect was much more pronounced in single-atom catalysts due to stronger interaction between single-atom and support atoms. Still in their early development, single-atom electrocatalysts will open new opportunities in various electrochemical reactions for future energy applications.

Off-Pathway Intermediates in the Conversion of Sugars to Plastic

Irene Tosi*¹, Anders Riisager¹, Esben Taarning², Sebastian Meier¹

1: Technical University of Denmark, Department of Chemistry, Kemitorvet, 2800-Kgs. Lyngby, Denmark.

2: Haldor Topsøe A/S, Haldor Topsøes Allé 1, 2800-Kgs. Lyngby, Denmark.

*Corresponding author email: itosi@kemi.dtu.dk

Carbohydrates are the most abundant compounds forming biomass and their conversion into chemicals is a central topic in the research of alternative resources for replacing the use of fossil feedstock. Using heterogeneous catalysts, simple sugars can be converted into chemicals and fuels. Recently, Lewis acidic zeolites have received much attention for their ability to bind and convert sugars. Particularly Sn-beta zeolite has been studied as catalyst for the production of methyl lactate and other monomers for bio-based polymeric materials.¹ The process is carried out in short-chain alcohol, normally methanol, because the catalyst shows higher stability in alcohol than in water.² Under these conditions, the sugar molecules react with the solvent to form methyl glycosides, resulting in complex reaction mixtures of isomeric glycosides (pyrano-furano and α - β forms) (Scheme 1). We use 2D ^1H - ^{13}C HSQC to identify and quantify all different forms of sugars as off-pathway intermediates in the conversion of sugars to plastic (Figure 1).

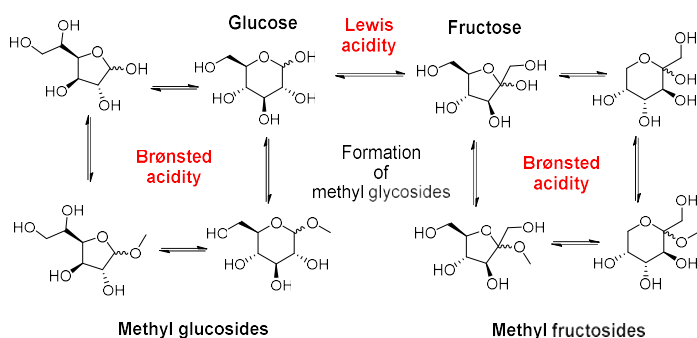

Scheme 1. Equilibrium between glucose and fructose in methanol using Sn-beta as catalyst the presence of Lewis acidity catalyzes the isomerization while the Brønsted acidity promotes the formation of methyl glycosides.

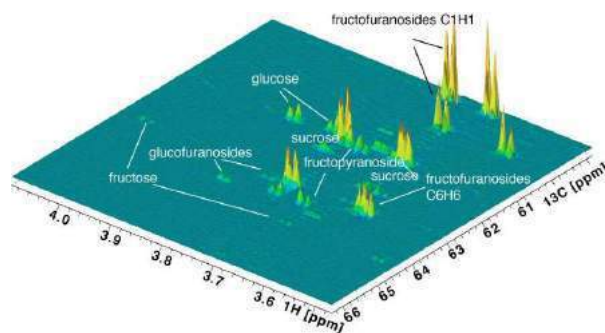

Figure 1. In the ^1H - ^{13}C HSQC spectra of the reaction mixtures it is possible to identify and quantify sugars and their methyl glycosides in their pyrano-furano and alfa-beta forms.

References:

- S. Tolborg, S. Meier, I. Sádaba, S. G. Elliot, S. K. Kristensen, S. Saravanamurugan, A. Riisager, P. Fristrup, T. Skrydstrup, E. Taarning, *Green Chem.*, 2016, 18, 3360-3369
- S. Saravanamurugan, I. Tosi, K. H. Rasmussen, E. E. Jensen, E. Taarning, S. Meier, A. Riisager, *Catal. Sci. Technol.*, 2017, 7, 2782-2788

Bioenergy conversion and storage systems: from conventional electrochemical cells to hybrid bioelectronic devices

Dmitry Pankratov, Qijin Chi*

NanoChemistry Group, Technical University of Denmark, DK-2800 Kongens Lyngby, Denmark

*Corresponding author: cq@kemi.dtu.dk

The rapid development and popularization of wearable and implantable self-sustainable electronics has increasingly demanded new-generation miniature and biocompatible power systems that can function under near-neutral pH solution and ambient conditions. Towards this end, enzymatic fuel cells (EFCs) using biocatalysts can offer an effective alternative to conventional batteries or fuel cells attributed to high biocatalytic activity, substrate specified selectivity, and non-toxic end products with ecofriendly impacts. Newly emerging photobioelectrochemical cells (PBCs), exploiting photosynthetic machinery for direct conversion of solar energy into electric power, is one of the most promising prospects for green and self-sustainable energy harvesting [1]. In addition, utilizing the inherent capacitance of electrodes as an active charge-storing element enables to enhance the efficiency of electron transfer processes proceeding in the system [2] and further miniaturization and simplification of a full-function device by elimination of internal capacitors in the electronic circuit. Remarkably, some pioneering attempts to design and create hybrid bioelectrochemical cells have already shown the positive prospects of such an approach, which was not able to achieve previously [3]. This invited talk aims to overview recent developments of EFCs and PBCs. In particular, we highlight their advantages, drawbacks and future perspectives towards practical applications.

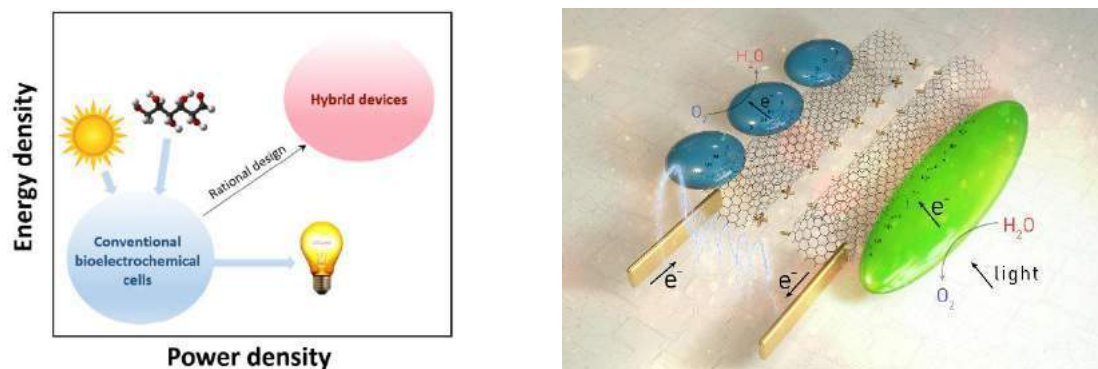

Fig. 1. Left: Schematic Ragone plot for conventional and hybrid bioelectrochemical cells. Right: Schematic representation of a hybrid PBC employing a photobioanode and an enzymatic biocathode.

References

- [1] D. Pankratov, G. Pankratova, T. P. Dyachkova, P. Falkman, H.-E. Åkerlund, M. D. Toscano, Q. Chi, L. Gorton *ACS Energy Lett.* **2017**, *2*, 2635 -2639.
- [2] G. Pankratova, D. Pankratov, K. Hasan, H.-E. Åkerlund, P.-Å. Albertsson, D. Leech, S. Shlev, L. Gorton. *Adv. Energy Mater.* **2017**, 1602285.
- [3] D. Pankratov, E. González-Arribas, Z. Blum, S. Shlev. *Electroanalysis* **2016**, *28*, 1250-1268.

Acknowledgments

This work was financially supported by the Marie Curie Actions under REA Grant Agreement No. 609405 (Ørsted-COFUND Postdoc fellowship at DTU). Q. C. acknowledges the financial support by Independent Research Fund Denmark-Nature Sciences (DFF-FNU, Project No. DFF-7014-00302).

Electrocatalysis caught in the act

Marie Lund Traulsen*, Daniel Bøgh Drasbæk, Peter Holtappels

Department of Energy Conversion and Storage, Technical University of Denmark

*Corresponding author email: matr@dtu.dk

High temperature electrocatalysis plays an important role in emerging energy technologies like high temperature fuel cells and electrolyzers. A crucial parameter in the development of these technologies is the development of electrodes that show a high initial activity and furthermore are able to maintain this high activity during long-term operation. Often the durability of these electrodes is challenged by the presence of contaminants in the gas feed, coking processes, segregation in the ceramic electrode materials themselves among others, which altogether will compromise the electrode performance.

To maintain a lasting, high activity of the ceramic electrodes a clear understanding of the processes occurring on the electrodes during operation is required. However, the challenging operating conditions for these electrodes (500-800 °C, controlled atmosphere, applied electric potential), limits the “spectroscopic toolbox” which can be applied during operation.

One spectroscopic tool that can be applied is Raman spectroscopy, which recently has been used to study differences in coking behavior between novel Ni and Co infiltrated perovskite electrodes. Furthermore, another recent operando Raman study shows that the surface composition of the ceramic electrodes is very dynamic, and can be controlled by the applied potential, thus the “active electrode surface” is much different from the electrode surface studied ex situ. These important findings must be taken into account in the development of new, highly active, durable electrodes for emerging energy technologies.

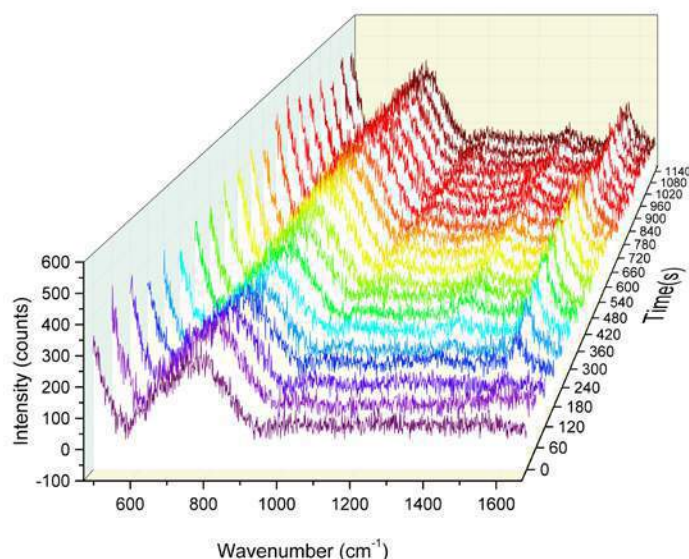

Figure 1. Operando Raman results showing graphite formation on Ni-STN based electrode at 850 °C when exposed to pure methane.

Hydrodeoxygenation of Bio-polymer Precursors with Base Metal Catalysts

Santosh G. Khokarale,¹ Shunmugavel Saravanamurugana,^{1,2} Anders Riisager*¹

1: Centre for Catalysis and Sustainable Chemistry (CSC), DTU Chemistry, Kgs. Lyngby, Denmark

2: Center of Innovative and Applied Bioprocessing (CIAB), Mohali, Punjab, India

*Corresponding author email: ar@kemi.dtu.dk

Future projections of declining and more expensive fossil reserves have stirred the chemical industry to find new pathways to convert biomass into renewable chemicals and fuels. The dominant storage form of carbon in nature is glucose accounting for 40-60 wt% of lignocellulosic biomass as cellulose. Industrial glucose processing involves its conversion to fructose, which is a key intermediate in reaction pathways towards furanic and carboxylic acid platform chemicals like, e.g. 5-hydroxymethylfurfural, 2,5-furandicarboxylic acid, lactic acid and levulinic acid [1].

Lactic acid (LA) is produced industrially in large scale from glucose by a fermentative process, however attractive, alternative chemo-catalytic processes based on Lewis acid zeolites are also emerging [2]. LA is an important feedstock to bio-degradable plastics, but can also serve as a feedstock for producing precursors (e.g. methyl propionate, MP) to existing acrylic plastics such as poly(methylmethacrylate) (PMMA). Currently, the preferred MP production route in industry is methoxycarbonylation of ethylene with carbon monoxide and methanol using a Pd-based homogeneous catalyst in a batch reactor despite major drawbacks such as, e.g. cautious handling of reactant as well as tedious catalyst recovery and recycling [3].

Here we report highly selective and efficient hydrodeoxygenation (HDO) of alkyl lactates to the corresponding alkyl propionates in alcohols with cheap and reusable base metal catalysts (Scheme 1). Under optimized reaction conditions an excellent yield of 77% MP was obtained from ML over Fe-Ni/ZrO₂ in methanol. Importantly, the introduced catalyst system proved generally applicable for HDO of compounds with α -hydroxyl groups, thereby making the system highly interesting for biomass valorization.

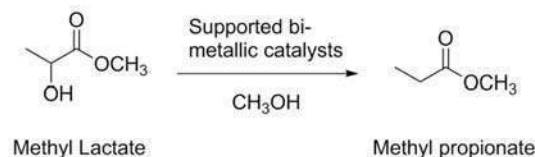

Scheme 1. HDO of ML to MP in methanol

[1] H. Li, J. He, A. Riisager, S. Saravanamurugan, B. Song, S. Yang, ACS Catal. 2016, 6, 7722.

[2] M.S. Holm, S. Saravanamurugan, E. Taarning, Science 2010, 328, 602.

[3] A.H. Tullo, Chem. Eng. News 2009, 87, 22; B. Harris, Ingenia 2010, 45, 18.



Electrocatalysis of Gold Nanostructures for Electrochemical Energy Conversion

Christian Engelbrekt, Nedjeljko Seselj, Mikkel Christiansen, Michal Wagner, Frederick N. Stappen, [Jingdong Zhang](#)*

Department of Chemistry, Technical University of Denmark, Kemitorvet, 2800, Kgs. Lyngby, Denmark

*Corresponding author email: jz@kemi.dtu.dk

Metallic nanomaterials have been developed rapidly for future applications in sensors, biomedicine and energy technology. Over a decade, we have been developing chemical methods to produce gold nanomaterials with various nanostructures including gold nanoparticles (AuNPs), core-shell particles and nanoporous gold films (NPGFs) aiming at efficient catalysts for reactions in bioelectrochemistry, fuel cells (FCs), electrochemical oxidation of CO and reduction of CO₂.¹⁻⁴ A facile synthesis protocol for atomically thin platinum (Pt) shells on top of AuNPs (Au@PtNPs) has been achieved under mild conditions,² where AuNPs are in the range of 8-80 nm. The Au@PtNPs exhibit a remarkable stability (>2 years) at room temperature. Electrochemical data clearly shows that the active surface is dominated by Pt. Interactions with the Au core increase the activity of the Pt shell by up to 55%, and improve catalytic selectivity compared to pure Pt. The Au@PtNPs show enhanced catalytic activity in electrooxidation of sustainable fuels (i.e. formic acid (FA), methanol (MeOH) and ethanol (EtOH)). Furthermore, Au_{core}/Pt_{shell}-graphene catalysts (G-Cys-Au@Pt) have been synthesized through exploitation of surface chemistry.³ Enhanced electrocatalytic oxidation of FA, MeOH and EtOH is observed with the increase in stability. Functional tests in direct FA, MeOH and EtOH-FCs exhibit 95, 53 and 107 % increased power densities for G-Cys-Au@Pt, respectively, over commercially available C-Pt catalyst. Recently, we have developed a chemical method to produce NPGFs by assembling AuNPs at liquid/air interface, starting from AuNPs in an aqueous solution.⁴ This method generates electrochemically stable cNPGFs, up to 20 cm² in size with an average thickness of 500 ± 200 nm, areal density of 50-150 μg/cm² and porosity as high as 85%. Importantly, cNPGFs can effectively catalyze both CO₂ reduction and CO oxidation electrochemically.

References

1. C. Engelbrekt, K. H. Sørensen, J. Zhang, A. C. Welinder, P. S. Jensen, J. Ulstrup, 'Green Synthesis of Gold Nanoparticles with Starch-glucose and Application in Bioelectrochemistry', *J. Mater. Chem.*, 2009, 19, 7839-7847.
2. C. Engelbrekt, N. Šešelj, R. Poredy, A. Riisager, J. Ulstrup, J. Zhang, 'Atomically Thin Pt Shells on Au Nanoparticle Cores: Facile Synthesis and Efficient Synergetic Catalysis', *J. of Material Chemistry A*, 2016, 4, 3278 – 3286.
3. N. Seselj, C. Engelbrekt, Y. Ding, H. A. Hjuler, J. Ulstrup, J. Zhang, 'Tailored electron transfer pathways in Au_{core}/Pt_{shell}-graphene nanocatalysts for fuel cells', *Advanced Energy Materials*, 2017, in press.
4. M. U.-B. Christiansen, N. Seselj, C. Engelbrekt, M. Wagner, F. N. Stappen, J. Zhang, 'Chemically Controlled Interfacial Nanoparticle Assembly into Nanoporous Gold Films for Electrochemical Applications', *J. of Material Chemistry A*, accepted 2017.

Acknowledgements

Finance support from Lundbeck foundation (R141-2013-13273), Danish Council for Independent Research (DFF – 1335-00330), to JZ, the Danish Council for Independent Research (DFF 5054-00107) to CE, and FP7 Marie Curie (COFUND Postdoc DTU 609405) to MW is acknowledged.

Session

C

Laptop Presentations

See session details and schedule on
www.sustain.dtu.dk



New In-situ electron microscopy methods for studying catalysts, electrocatalyst and other functional materials processes

Murat Nulati Yesibolati¹, Hongyu Sun¹, Kristian Mølhave*¹

1: DTU nanotech

*Corresponding author email: nuye@nanotech.dtu.dk

Catalysis is a key process for converting reactants into products, and it plays a critical role in chemical and energy conversions, and improving catalysis efficiency is essential to reduce our resource and energy consumption. Better understanding of the dynamic processes during catalyst synthesis and use, with detailed information in structural features like facets and surface defects, particle size variances, composition, supporting substances *etc.* is essential for designing more efficient catalysts. In-situ electron microscopy methods can give direct views of these processes with atomic scale spatial and video rate temporal resolution.

SiNx window based in-situ electron microscopy (shown in Figure 1) make it possible to study processes in liquids or gas.

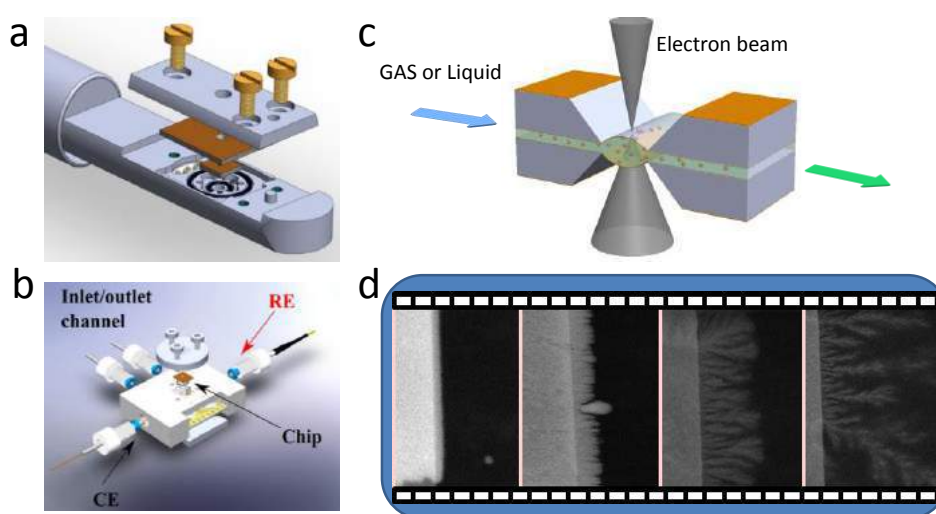

Figure 1, Schematic diagram of a SiNx membrane based chemical/electrochemical cell for catalysis process study, **a**: TEM cell; **b**: SEM cell; **c**: schematic illustration of window region and STEM imaging; **d**: in-situ electrodeposited copper with different morphologies (phosphate tuned) show high formic acid selectivity for CO₂ reduction [1].

[1] J. Zhao, S. Canepa, M. N. Yesibolati, K. Mølhave, Z.C.Xu et al, Phosphate tuned copper electrodeposition and promoted formic acid selectivity for carbon dioxide reduction, *J. Mater. Chem. A*, 2017, 5, 11905

Optimizing catalytic deoxygenation of biomass derived fast pyrolysis vapors

Andreas Eschenbacher¹, Peter Arendt Jensen¹, Ulrik Birk Henriksen², Jesper Ahrenfeldt², Anker Degn Jensen^{1*}

¹Technical University of Denmark, Department of Chemical Engineering, DTU Lyngby Campus, Building 229, DK-2800, Denmark

²Technical University of Denmark, Department of Chemical Engineering, DTU Risø Campus, Building 313, Frederiksborgvej 399, 4000 Roskilde, Denmark

AJ@kt.dtu.dk

1 Introduction and scope

The concept of de-centralized smaller scale pyrolysis plants that locally valorize available biomass by densifying its energy content into a bio-crude is of increasing interest world-wide. Fast pyrolysis of biomass produces a high yield of bio-oil through well-established technologies at optimized temperature, pressure, and residence time of the liberated pyrolysis vapors¹. Reducing the oil's oxygen content and acid number to stabilize the oil deserve prioritized attention² and allow further processing in oil refineries. We propose a biomass based polygeneration plant (Fig. 1) that is able to co-produce heat, power, bio-oil and fertilizer (ashes) with high overall efficiency and flexibility. The concept is suitable for medium-scale decentralized plants when including gas combustion engines and also for large-scale power plants if the engine is replaced by a boiler and steam cycle. Deoxygenation can be obtained by catalytic upgrading over zeolites. To date, the medium pore size ZSM-5 zeolite has been found to provide a high aromatic yield and the least amount of coke³ in upgrading of pyrolysis vapors. However, coke formation in the reaction of pyrolysis vapors over the zeolites and steam induced dealumination leads to rapid deactivation⁴. Maintaining the catalyst's activity during multiple regeneration steps is needed to prove the economic attractiveness of bio-oil plants. Optimization of the catalyst system and testing of the catalyst under real conditions is thus the main focus of this PhD study.

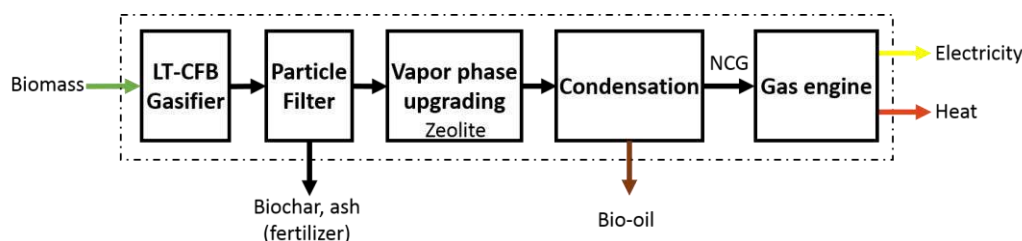

Figure 1: Process scheme of polygeneration plant comprised of various technologies.

2 Experimental approach and results

A bench scale fast pyrolysis unit is used to screen the performance of parent and modified catalysts. The oils are analyzed for water and elemental composition and subjected to GC-MS and SEC analysis. Mass and energy balances are conducted to corroborate the results. Catalytic vapor deoxygenation increases the heating value (Table 1).

Repeated upgrading and regeneration cycles have been conducted for straw and wood derived pyrolysis vapors with the parent ZSM-5 zeolites. The temperature during oxidative regeneration has to be carefully controlled in order avoid a loss of acid sites by steam. Through introduction of mesopores by NaOH leaching we aim to improve both the zeolite's active time on stream and the long-term stability throughout multiple regeneration cycles. The modified catalysts are analyzed by nitrogen and argon physisorption, NH₃-TPD, XRD, XRF and TEM analysis to correlate the catalyst activity with its structure and acidity. Both acidity and ratio of micro to mesopores (Fig. 2) are steered towards limited coke formation at maximum valuable product yield. Further modifications of the zeolite for enhanced hydrothermal stability are considered in order to speed up the regeneration.

As a next step we will test the catalytic performance of the prepared hierarchical zeolites.

Table 1: Oxygen content and higher heating values of feedstock and bio-oils

source	oxygen [wt-%] _{daf}	HHV _{ab} [MJ/kg]
wood feedstock	40.8	22
heavy fraction of pyrolysis oil	30.8	25.4
heavy fraction of upgraded pyrolysis oil	22.6	29.9

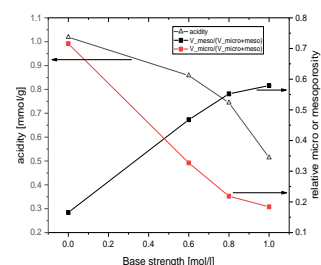

Figure 2: Change in acidity and relative micro/mesopore volume of ZSM-5 with increasing NaOH leaching severity

References

- [1] Czernik, S. & Bridgwater, A. V., *Energy & Fuels* 18, 590–598 (2004)
- [2] Huber, G. W. *Am. Chem. Soc.* 1–177 (2007)
- [3] Jae, J. *et al. J. Catal.* 279, 257–268 (2011)
- [4] Horne, A., Williams, P. T., *J. Anal. Appl. Pyrolysis* 34, 65–85 (1995)

Session

C

Poster Presentations

See session details and schedule on
www.sustain.dtu.dk



A toolbox to study precious metal nano- catalysts: surfactant free synthesis, characterization and catalytic activity

J. Quinson^{*1}, L. Kacenauskaite¹, M. Inaba¹, A. A. Swane¹, S. B. Simonsen², L. Theil Kuhn², J. J. K. Kirkensgaard³, K.Ø.M Jensen¹, M. Oezaslan⁴, S. Kunz⁵, T. Vosch¹ and M. Arenz^{*1,6}

1: Nano-Science Center, University of Copenhagen, Universitetsparken 5, 2100 Copenhagen Ø, Denmark

2: Department of Energy Conversion and Storage, Technical University of Denmark, Frederiksborgvej 399, 4000 Roskilde, Denmark

3: Niels Bohr Institute, University of Copenhagen, Universitetsparken 5, 2100 Copenhagen Ø, Denmark

4: School of Mathematics and Science, Department of Chemistry, Carl von Ossietzky Universität Oldenburg, 26111 Oldenburg, Germany

5: Institute of Applied and Physical Chemistry, University of Bremen, Leobenerstraße, 28359 Bremen, Germany

6: Department of Chemistry and Biochemistry, University of Bern, Freiestrasse 3 CH-3012 Bern, Switzerland

*Corresponding authors email: jonathan.quinson@chem.ku.dk, matthias.arenz@dcb.unibe.ch

To develop an efficient catalyst for energy-related reactions (e.g. the oxygen reduction reaction (ORR) taking place in fuel cells), a careful control on every preparation steps is fundamental. The **synthesis** route, the **physical properties** of the obtained **nanoparticle catalyst** (e.g. composition of the catalyst, size, etc.) and further **processing and formulation** (e.g. nanoparticle loading on support, nature of the support, 'ink' formulation, etc.) can strongly influence the **catalytic performances** (e.g. maximum activity, stability, selectivity, etc.). To optimize a catalyst, it is necessary to **systematically control** and **systematically study** the effect of these different parameters.

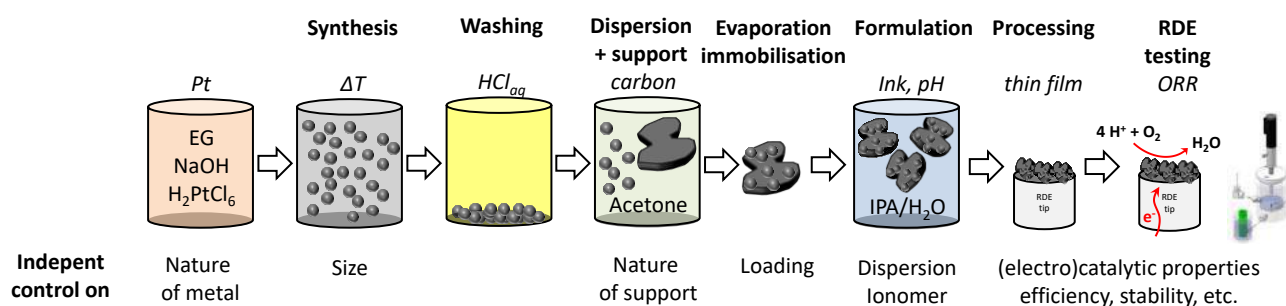

Fig. 1. Scheme of the steps in the toolbox approach to systematically study platinum catalysts for the ORR

Performing systematic studies is challenging with commercial catalysts since not all properties can be tuned independently. A **toolbox approach**¹ has been developed and shown over the years to be suitable to perform systematic studies and propose optimization strategies of platinum catalysts for the ORR.²

In this presentation, recent findings and development are highlighted regarding (1) the synthesis of precious metal nanoparticles (e.g. Pt) in particular regarding **size control** and developing **green synthesis** approaches³. (2) An overview of the **different characterization** techniques used and how they complement each other is given (e.g. Transmission electron microscopy, X-ray absorption spectroscopy, small angle X-ray scattering, and pair distribution function analysis). (3) Further **development** of the toolbox are highlighted and how a **transfer of knowledge** is/could be performed to other areas of electrocatalysis (e.g. for the oxygen evolution reaction performed in electrolyzers), of catalysis (e.g. for chemical production) or other fields of research (e.g. environmental science) is presented.

References.

1. J. Speder, L. Altmann, M. Roefzaad, M. Baumer, J. J. K. Kirkensgaard, K. Mortensen and M. Arenz, *Physical Chemistry Chemical Physics*, 2013, **15**, 3602-3608.
2. J. Speder, A. Zana and M. Arenz, *Catalysis Today*, 2016, **262**, 82-89.
3. L. Kacenauskaite, J. Quinson, H. Schultz, J. J. K. Kirkensgaard, S. Kunz, T. Vosch and M. Arenz, *ChemNanoMat*, 2017, **2**, 89-93.

Metal-Organic Framework Derived FeP/C Interlocked Graphene Hybrid Composite for Hydrogen Evolution Reaction

Wei Huang¹, Hongyu Sun², Kristian Mølhave² and Jingdong Zhang^{*1}

*Corresponding author email: jz@kemi.dtu.dk

Due to large-scale energy demanding, global warming and limited sources, developing clean energy technology is very imperative. Hydrogen (H₂) is a clean and sustainable energy source for replacing fossil fuels in the future. Currently, Platinum (Pt) and Pt-based catalysis exhibit the most effective performance for the hydrogen evolution reaction (HER). However, Pt-based catalysts give multiple obstacles, such as limited resources, high cost, thus restrict the further development. Therefore, exploring and designing efficient and durable noble-metal-free HER catalysts utilizing earth-abundant elements (such as iron resource) to replace Pt for HER catalysis are important[1, 2] In this poster, we presented an in-situ approach for metal-organic framework (MOF) derived FeP/C interlocked graphene hybrid composite for HER, C@FeP nanoparticles interconnected with reduced graphene oxide (rGO), in which networks could provide abundant surface for the loading of active materials with sufficient active sites for the HER. It is expected that FeP/C interlocked graphene hybrid composite shows good electrocatalytic ability and durability for HER.

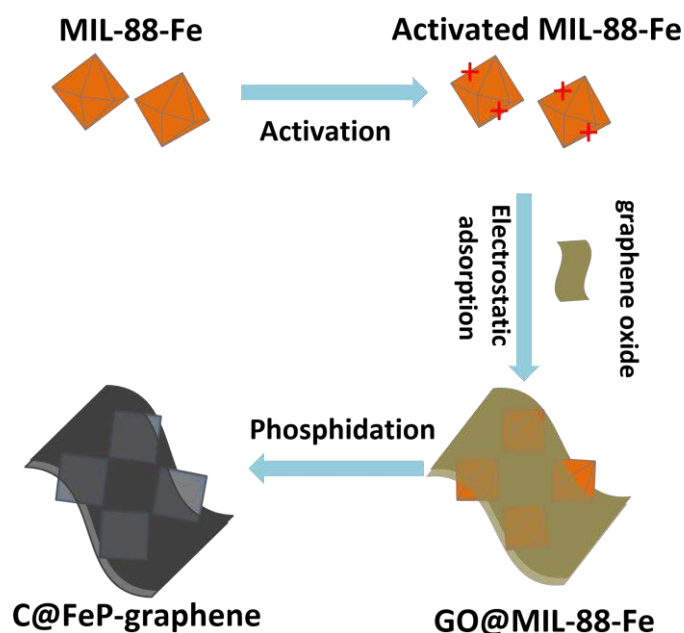

Fig.1. Schematic illustration of the synthesis process of C@FeP-graphene composite. Not drawn to scale.

Acknowledgments

Wei Huang acknowledges the China Scholarship Council for a PhD scholarship (201706220080).

References

- [1] D.G. Nocera, The Artificial Leaf, *Acc. Chem. Res.*, 45 (2012) 767-776.
- [2] J.A. Turner, Sustainable Hydrogen Production, *Science*, 305 (2004) 972-974.

Electrocatalytic oxidation of $K_4[Fe(CN)_6]$ by metal-reducing bacterium *Shewanella oneidensis* MR-1

Zhiyong Zheng¹, Yong Xiao¹, Ranran Wu¹, Hans Erik Mølager Christensen¹, Feng Zhao² and Jingdong Zhang*¹

1: Department of Chemistry, Technical University of Denmark, Kemitorvet, 2800, Kgs. Lyngby, Denmark

2: CAS Key Laboratory of Urban Pollutant Conversion, Institute of Urban Environment, Chinese Academy of Sciences (CAS), Xiamen, 361021, China

*Corresponding author email: jz@kemi.dtu.dk

The microbial metabolic activities between metals and bacteria play a vital role on biogeochemical cycling of metal compounds¹. One of these activities is extracellular electron transfer (EET), in which some microbes exchange electrons with external redox minerals, electrodes, or even other microorganisms²⁻⁴. The bacteria can either take electrons or give electrons. *Shewanella oneidensis* MR-1 (MR-1) is electrochemical active, it can transfer electrons from cell to extracellular electron acceptors including Fe(III) (hydro)oxides. In this study, we report that MR-1 electrocatalyze the oxidation of an inorganic redox compound $K_4[Fe(CN)_6]$. A pair of symmetric peak in the cyclic voltammetry (CV) of $K_4[Fe(CN)_6]$ were found on bare glassy carbon electrode (GCE) (Scheme 1). Surprisingly, when the GCE is coated MR-1, the anodic peak almost sustained at the same level; while the cathodic peak apparently shrunk (Scheme 1, right). We attribute this phenomenon to the electrocatalytic oxidation by MR-1. The discovery of the ability to oxidize $[Fe(CN)_6]^{4-}$ by MR-1 broadens our horizon of the role that dissimilatory metal reduction bacteria play in the environment.

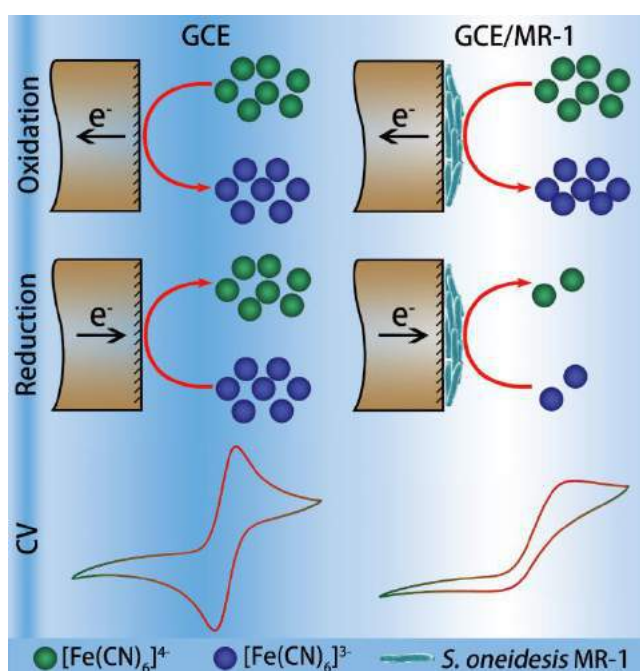

Scheme 1 The conversion of $[Fe(CN)_6]^{4-/3-}$ on GCE (left) and electrocatalysis oxidation of $[Fe(CN)_6]^{4-}$ to $[Fe(CN)_6]^{3-}$ by GCE coated with MR-1 (right).

References

1. C. R. MYERS and K. H. NEALSON, *Science*, 1988, **240**, 1319-1321.
2. Y. Xiao, E. Zhang, J. Zhang, Y. Dai, Z. Yang, H. E. M. Christensen, J. Ulstrup and F. Zhao, *Sci Adv*, 2017, **3**, e1700623
3. X. Tian, F. Zhao, L. You, X. Wu, Z. Zheng, R. Wu, Y. Jiang and S. Sun, *PCCP*, 2017, **19**, 1746-1750.
4. P. T. Ha, S. R. Lindemann, L. Shi, A. C. Dohnalkova, J. K. Fredrickson, M. T. Madigan and H. Beyenal, *NAT COMMUN*, 2017, **8**, 13924.

Acknowledgements

Supported from the China Scholarship Council (CSC) (No. [2016]3100), Carlsberg foundation (CF15-0164), Universities Denmark, Otto Mønsted foundation is greatly appreciated.

Graphene-glucose oxidase bioanodes for enzymatic biofuel cells

J. Tang¹, R. M. L. Wercheister¹, C. Engelbrekt¹ and J. Zhang^{1,*}

¹Technical University of Denmark, Department of Chemistry, 2800 Kgs. Lyngby, Denmark

* Corresponding author email: jz@kemi.dtu.dk

Enzymatic biofuel cells (EBFCs) are electrochemical devices, that produce electricity from energy stored in fuel molecules under catalysis of enzymes, Fig. 1a. An EBFC contains a bioanode and/or a biocathode, in which enzymes are used to catalyse oxidation of fuel molecules such as sugars, and dioxygen reduction, respectively. The advantage of EBFCs is to generate energy from abundant fuel molecules without using expensive noble metals. On the other hand, development of EBFCs is still at the research stage due to instability of the biocatalysts. Here, we are developing a bioanode using graphene [1] as supporting material, polyethylenimine (PEI) as linker and glucose oxidase (GOD) as the chosen enzyme, Figure 1b. GOD can catalyze oxidation of glucose to gluconolactone, but needs a mediator to assist electron transfer between the enzyme and electrodes [2]. The redox molecule ferrocene carboxylic acid (FcCOOH) is immobilized together with GOD on the bioanode. Structure and composition of the graphene-GOD bioanode are shown in Fig. 1b. Electrochemical catalytic performance of the prepared bioanode has been observed, Fig. 1c. An EBFCs with the bioanode and the commercial Pt cathode have been successfully assembled and systematically investigated. The assembled EBFCs show good reproducibility. EBFCs provide maximum output power density $2.47 \mu\text{W cm}^{-2}$ at $35 \text{ }^\circ\text{C}$, indicating the optimized activity of EBFCs fed with glucose.

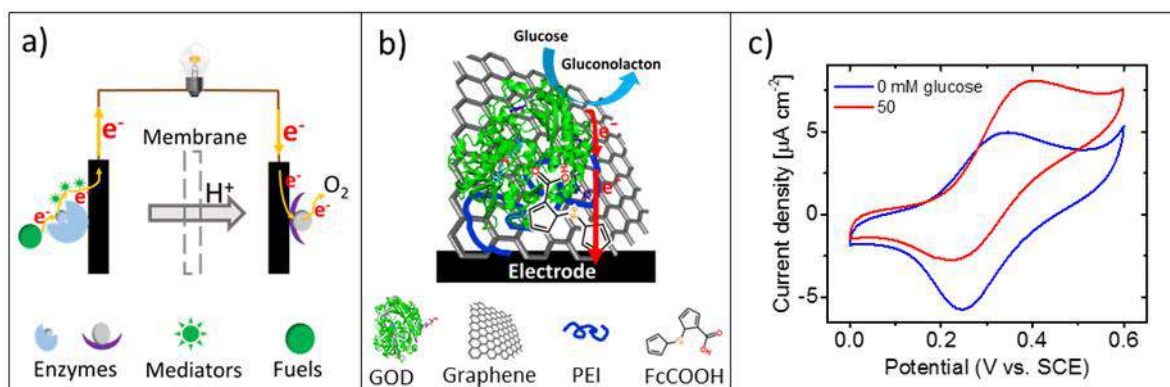

From

Fig. 1. Illustration of (a) an enzymatic biofuel cell and (b) the graphene-GOD bioanode. (c) Cyclic voltammetry of the graphene-GOD in the absence (black) and presence (blue) of glucose in 20 mM phosphate buffer, pH 7.0. Scan rate 10 mV/s. The graphene-GOD bioelectrode was prepared by dropcasting 20 μL graphene-PEI-FcCOOH-GOD solution synthesized by mixing 200 μL 18 mg/mL GOD and 800 μL graphene-PEI-FcCOOH ink for 20 hours at $4 \text{ }^\circ\text{C}$, and then 10 μL 1.0 wt% Nafion solution on the $4.0 \times 5.0 \text{ mm}^2$ carbon paper electrode. The ink was produced by first heating 17 mL Milli-Q, 5.0 mg FcCOOH, 2.0 mL 1.0 mg/mL graphene oxide solution, and 1.0 mL 40 mg/mL PEI solution together for 60 minutes at $95 \text{ }^\circ\text{C}$ and concentrating to 4.0 mL.

Acknowledgments

Finance support from Danish Research Council (FTP-YDUN) is greatly appreciated.

References

- [1] M. A. Raj and S. A. John, *J. Phys. Chem. C*. 4326, 117 (2013).
- [2] B. Kowalewska and K. Jakubow, *Sensors. Actuat. B-Chem.* 852, 238 (2017).

Structure sensitivity in the electrocatalytic reduction of CO₂ with gold catalysts

Mezzavilla S.¹, Duarte R.¹, Maagaard T.¹, Stephens I.E.L.², Horch S.¹, Seger B.¹, Chorkendorff I.^{1*}

1: SurfCat, Department of Physics, Technical University of Denmark, DK-2800 Kgs. Lyngby, Denmark

2: Department of Materials Imperial College London, 2.03b, Royal School of Mines London SW7 2AZ, England

*Corresponding author email: ibchork@fysik.dtu.dk

The electrocatalytic reduction of CO₂, that is, the conversion of CO₂ to CO, hydrocarbons and alcohols in an electrochemical cell, represents a very promising strategy to store renewable electricity in chemical compounds and to facilitate the introduction of renewable energy sources in the chemical industry. Gold is one of the most active electrocatalysts capable to produce CO at moderate overpotentials and high selectivity.¹ Many strategies, such as nanostructuring,² the exploitation of catalyst-support effects³ and grafting with organic ligands⁴, have been recently proposed to further enhance its performance. Even so, small improvements have been achieved so far in comparison to the performance of bulk Au electrodes and little is known about the nature of the catalytic active sites.¹ Theoretical studies predict that stepped surfaces – and, more in general, under-coordinated sites – are the most active sites for the CO₂ electroreduction.⁵ Even so, no experimental evidence has been brought forward in support of these hypotheses. In this work, a thorough experimental investigation of Au single crystals having preferential surface orientations and well-defined features is presented. The performance of terrace-rich crystals, such as (111) and (100), and a steps-rich (211) electrode is compared to assess their differences in selectivity and reaction rates. Furthermore, the presence of adsorbed reaction intermediates and spectators will be discussed. The findings of this study will guide the design and synthesis of efficient catalysts. Furthermore, the results obtained with these model catalysts may provide important elements to optimize the theoretical description of the phenomena occurring at the electrochemical interface and therefore improve the prediction accuracy of future screening investigations.

References

- (1) Jovanov, Z. P.; Hansen, H. A.; Varela, A. S.; Malacrida, P.; Peterson, A. A.; Nørskov, J. K.; Stephens, I. E. L.; Chorkendorff, I. *J. Catal.* **2016**, *343*, 215–231.
- (2) Zhu, W.; Zhang, Y.-J.; Zhang, H.; Lv, H.; Li, Q.; Michalsky, R.; Peterson, A. A.; Sun, S. *J. Am. Chem. Soc.* **2014**, *136* (46), 16132–16135.
- (3) Kim, J.-H.; Woo, H.; Choi, J.; Jung, H.-W.; Kim, Y.-T. *ACS Catal.* **2017**, *7* (3), 2101–2106.
- (4) Fang, Y.; Flake, J. C. *J. Am. Chem. Soc.* **2017**, *139* (9), 3399–3405.
- (5) Back, S.; Yeom, M. S.; Jung, Y. *ACS Catal.* **2015**, *5* (9), 5089–5096.

Convenient and Sustainable Hydrogen Storage using Liquid Organic Hydrogen Carrier (LOHC) Technologies

Alexander Sogaard^{1*}, Anders Riisager¹, Andreas Bösmann², Peter Wasserscheid²

1: Centre for Catalysis and Sustainable Chemistry, DTU Chemistry, Kgs. Lyngby, Denmark

2: Institute for Chemical Reaction Engineering, Friedrich-Alexander Universität Erlangen-Nürnberg, Erlangen, Germany

*Corresponding author email: ar@kemi.dtu.dk

Hydrogen is an attractive vector in the transition of the energy sector from a high dependence on fossil fuels to an increasing amount of energy from renewable and sustainable sources. Hydrogen can be produced from water electrolysis using green energy sources like solar and wind energy, which reduces CO₂ emission and thus the contribution to anthropogenic climate change. By storing hydrogen, it can compensate for the intermittent nature of renewable energy sources in order to sustain a continuous energy supply.

Conventional hydrogen storage involves compressed gaseous hydrogen and cryogenic liquid hydrogen, which both are expensive technologies involving technical challenges. An alternative storage technology is the use of Liquid Organic Hydrogen Carriers (LOHCs). In LOHCs, hydrogen is chemically bound via a catalytic hydrogenation reaction in times of overproduction and cheap energy, and later transported and released through a catalytic dehydrogenation reaction at the time and place of energy need [1].

Hydrogen in LOHCs are stored under ambient conditions, which simplifies their handling and enables transport and storage using already existing infrastructure for liquid fuels resulting in reduced investment cost for implementation. Commercially available LOHC systems are typically based on aromatic hydrocarbons, which exhibit favorable (eco)toxicity profiles. However, due to high dehydrogenation enthalpies reactions are often performed above 300 °C, which possess a challenge for heat integration with state-of-the-art PEM fuels for clean energy production [2]. Hence, alternative LOHC systems, which can operate under significantly milder conditions, are attractive.

In this work, reversible catalytic hydrogenation/dehydrogenation of N-functionalized heterocycles are demonstrated as efficient LOHC systems operating as low as 120 °C. The dehydrogenation has been performed with a homogeneous hydrogenation iridium catalyst in biphasic reaction mode using a molten salt as catalyst immobilization phase. This approach facilitated easy catalyst separation and required only a small amount of catalyst phase to store large amounts of hydrogen, which is beneficial for future large-scale continuous hydrogen storage and release.

[1] Teichmann, D., Arlt, W., Wasserscheid, P., Freymann, R., 2011, *Energy Environ. Sci.*, 4, 2767

[2] Rosli, R. E., Sulong, A. B., Daud, W. R. W., Zullizfley, M. A., Husaini, T., Rosli, M. I., Majlan, E. H., Haque, M. A., 2017, *Int. J. Hydrog. Energy*, 42(14), 9293–9314.

Hydroformylation with Integrated Catalytic-Membrane Separation Reaction System

J. M. Marinkovic¹, A. Weiß², E. J. García-Suárez¹, M. Haumann², A. Riisager*¹ and R. Fehrmann¹

1: Centre for Catalysis and Sustainable Chemistry, Department of Chemistry, Technical University of Denmark (DTU), 2800 Kgs. Lyngby, Denmark

2: Lehrstuhl für Chemische Reaktionstechnik, Friedrich-Alexander-Universität (FAU), 91058 Erlangen, Germany

*Corresponding author email: ar@kemi.dtu.dk

Catalysis with supported homogeneous catalyst systems has successfully been established over the last decades as an industrially attractive approach.^[1] Hydroformylation of olefins by syngas to produce aldehydes is an important industrial reaction.^[2] However, the long-term catalytic performance of such systems is often negatively influenced due to the formation of “heavies” by undesired condensation reactions hampering activity and selectivity.

In the HORIZON2020 project Reactor Optimisation by Membrane Enhanced Operation (ROMEEO)^[3] a new “two-in-one” reactor concept is being developed. The unique ROMEEO reactor will overcome present challenges in the hydroformylation technology and its industrial application by combining two process steps in one module as depicted in Figure 1.

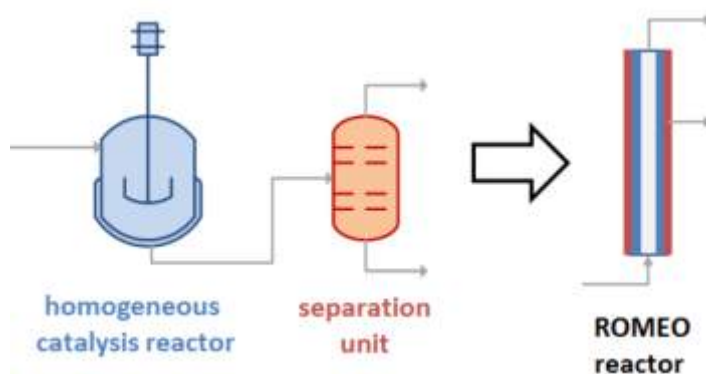

Fig. 1. Reactor Optimisation by Membrane Enhanced Operation (ROMEEO) technology combines two standard process steps.

The ROMEEO reactor is based on a catalytically active membrane, which is combined with a homogeneous catalyst to generate the “two-in-one” reactor module. Depending on the properties of the membrane, either the product or byproduct passes through the membrane once the reaction has taken place at the catalyst surface.

Preliminary investigations of olefin hydroformylation have demonstrated that the system is catalytically active affording high activity and selectivity. The results indicate that the ROMEEO “two-in-one” reactor concept has a great potential to be applied in the chemical industry. Furthermore, a reduction in emissions, energy consumption, space needs and costs in the chemical industry are expected with this novel reactor type.

Acknowledgments

This project has received funding from the European Union’s Horizon 2020 research and innovation programme.

References

- [1] S. Bhaduri, D. Mukesh. Homogeneous Catalysis: Mechanisms and Industrial Applications, 2nd Edition. *John Wiley & Sons*, 2014.
- [2] R. Franke, D. Selent, A. Börner. Applied Hydroformylation. *Chemical Reviews*, 2012, 112 (11), 5675-5732.
- [3] <http://www.romeo-h2020.eu>

Session

D

Oral Presentations

See session details and schedule on
www.sustain.dtu.dk



Dronebased gas measurements – detections of leakages of methane

Christian Juncher Jørgensen^{*1}, Frantz Bræstrup¹, Jacob Mønster¹ & Karsten Fuglsang¹

¹: FORCE Technology, Department of Metrology and Air Environment

*: Corresponding author chjj@force.dk

Methane (CH₄) is a greenhouse gas contributing strongly to global warming. Global emissions are estimated at 559 Tg CH₄ year⁻¹ with approximately two-thirds of global emissions attributable to anthropogenic activities, such as agriculture, energy production and waste disposal (Sanunois et al, 2016). Because of CH₄'s high global warming potential and short lifetime in the atmosphere compared to CO₂, its mitigation offers the possibility to slow climate change efficiently in a shorter time horizon compared to CO₂ mitigation initiatives. The emergence of new measurement techniques and analytical platforms holds promise for constraining the global methane budget by improving our knowledge of emissions from anthropogenic CH₄ sources and providing means to reduce CH₄ emissions to the atmosphere. In addition to climate benefits, reducing CH₄ emissions could provide business and employment opportunities (Sanunois et al, 2016) as well as improving net efficiency in the energy sector (Energiforsk, 2015).

Detection and quantification of CH₄ emissions are typically conducted either as ground based direct gas measurements based on a range of gas sensor techniques (e.g. semi-conductor, pellistor, infra-red (IR) absorption, gas chromatography or flame ionization detector) or via remote sensing techniques using open path IR detectors or IR cameras sensitive to CH₄. Recent breakthrough measurement technologies such as cavity ringdown spectrometry and open path diode laser instruments allow high precision measurements of CH₄, both at the surface (Christiansen and Jørgensen, 2017; Jørgensen et al, 2015; Mønster et al, 2014) and in the atmosphere (Golston et al, 2017). Low-cost gas sensors with both low weight and low power consumption have in recent years become increasingly used for air pollution monitoring (Bossche et al, 2017) with the potential of expanding the monitoring capabilities at a dramatically reduced cost.

In this project, we investigate how drone mounted, low cost CH₄ sensors can be applied to localize hotspots of CH₄ emissions in both natural and industrial landscapes. The aim is to develop a technological solution, which utilizes and combines the cost- and weight-effectiveness of small, low cost CH₄ sensors with adaptive drone flight planning. The solution will improve the spatial and temporal coverage of CH₄ measurements in potential leakage areas providing a more cost-efficient means to quickly localize emissions of CH₄.

REFERENCES

1. Bossche, M. et al (2017) Potential of low-cost gas sensor for atmospheric methane monitoring. **Sensors and Actuators B: Chemical**, pp. 501-509.
2. Christiansen, J.R. & Jørgensen, C.J. (2017) Spatial Survey of CH₄ Uptake in an Arctic Landscape in Greenland. Picarro <http://www.picarro.com/sites/default/files/G4301-CS01-V1.0-170301.pdf>
3. Energiforsk (2015) Measurements of methane emissions from biogas production. Report 2015:158
4. Jørgensen, C.J. et al (2015) Net regional methane sink in High Arctic soils of northeast Greenland. **Nature Geoscience**, Vol. 8, pp. 20–23.
5. Golston, L.M. et al (2017) Lightweight mid-infrared methane sensor for unmanned aerial systems. **Applied Physics B**, 123:170.
6. Mønster, J. et al (2014) Quantifying methane emission from fugitive sources by combining tracer release and downwind measurements – A sensitivity analysis based on multiple field surveys, **Waste Management**, Vol. 34, pp. 1416-1428.
7. Saunois, M. et al (2016) The growing role of methane in anthropogenic climate change. **Environmental Research Letters**, 120207

Bringing the drone industry to the next level

Christoffer Greenfort
Danish Chamber of Commerce, Senior Consultant, Transport & Infrastructure
DroneDanmark, Head of the Secretariat



cgr@danskerhverv.dk

State of the Union

The past years have brought sizeable advances in the worldwide drone technology. Denmark has had a lot of focus on the area, especially when it comes to research and academia.

The Danish legislators have been very cooperative, giving us a solid framework to base our research and practical use of drones on. The unique way the Danish bureaucracy works means, that the industry has had a direct access to the decision makers who have also show a real interest in collecting the industries findings and practical experiences.

Going to market

Our industry has reached a point where it is crucial, that we can show some real-world results. If we want to go to the next level, we can no longer hide behind the often heard “we are a fledgling industry slowing building up” – we have done that for some time now and the focus needs to be on commercializing drones.

I think there are several ways to kick start this process:

1. We must look at the established industries and offer them the solutions, that will make their everyday business easier or more profitable – we can't wait for them to come to us.
2. We must work closer together. Like many newer industries before us, we have the tendency to see each other strictly as competitors. There are several organizations in DK, that focuses on their separate areas of the industry – join them and help them. They are already supporting each other and working together.
3. We must help the decision makers in keeping the rules and regulations updated and modern. They are willing to change the rules providing we present them with well thought through ideas and projects. Such projects will help pave the way for more innovation.
4. We must look at projects and industries both nationally and internationally

The time is now to show what we have been working towards through the years.

Drone-mounted technologies for sampling and/or detecting the Real Time three dimensions extent of contamination

Angelo Fienga – anfienga@gmail.com

The project ATLASS (Aerial and Terrestrial Lab for Automatic Sampling and Survey) has its roots in our startup idea to complement traditional air sampling technologies with the flexibility offered by other innovative technologies, including drones, Unified Communications, IoT and, where possible, artificial intelligence.

Core of the ATLASS project is an integrated system for measuring the concentrations of principal pollutants in the air (inside and outside and above the relevant area) using a drone equipped with sensors for 3D DTM

modeling, a multi-sensor remote controlled lab for air analysis (dust, CH₄, CO, CO₂, NO_x, H₂S and up to 50 different sensors) and thermal camera.

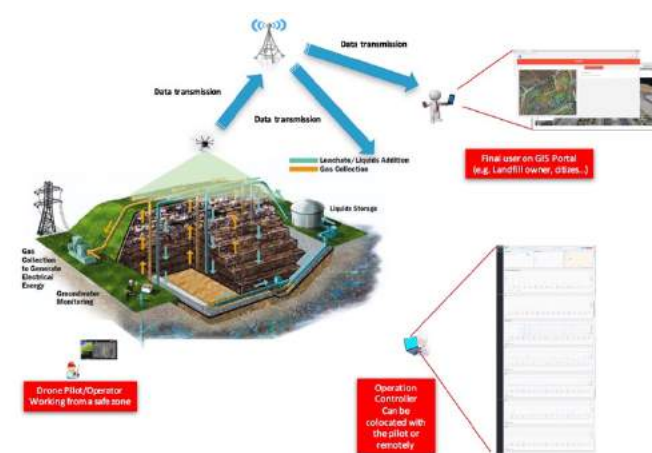

The system dramatically improves the temporal resolution of air measures, with respect to the current technologies (meteorological station and fixed camera), thanks to an fast sampling of large air volumes.

A GIS geodatabase connected to a custom mobile app and/or web app, allows to display and download data (i.e. air mapping quality and tables

of chemical data survey).

More, information coming from drone (and land) mounted sensors contribute to create a more complete and real time situational awareness for operators that have to operate in an environment that could be potential at risk. Last, but not least, Unified Communication techniques create the capability to spread much more efficiently the situational awareness across multiple people and pull relevant experts in a single cooperative room where people and sensors can contribute to solve issues in a quicker, less risky and less costly way.

Session

D

Poster Presentations

See session details and schedule on
www.sustain.dtu.dk



Outdoor luminescence imaging strategies for drone-based PV array inspection

Gisele A. dos Reis Benatto^{1*}, Nicholas Riedel¹, Claire Mantel¹, Sune Thorsteinsson¹, Peter B. Poulsen¹, Søren Forchhammer¹, Kenn H. B. Frederiksen², Jan Vedde³, Harsh Parikh⁴, Sergiu Spataru⁴ and Dezso Sera⁴

1: Department of Photonics Engineering, Technical University of Denmark, Frederiksborgvej 399, 4000, Roskilde, Denmark

2: Kenergy, Grønningen 43, 8700, Horsens, Denmark

3: SiCon Silicon & PV consulting, J N Vinthersvej 5, 3460, Birkerød, Denmark

4: Aalborg University, Pontoppidanstraede 101, 9220, Aalborg, Denmark

*Corresponding author email: garb@fotonik.dtu.dk

Regular fault detection for effective maintenance is highly important to ensure expected return on investment (ROI) of small and large-scale photovoltaic (PV) installations. Present day PV panels are designed to operate for 25-30 years, however field experience shows that after 11-12 years of operation, 2% or more of all PV panels fail [1].

In practice, the frequency and inspection detail level is often limited by manpower and cost. Presently, drone-based infrared (IR) thermography inspection of solar plants is a reality [2], [3]. The accuracy of thermographic fault detection though, presents limitations – primarily related to deconvoluting the failure signature into failure type and severity, which can be overcome when performed in combination to electro-(EL) or photo-(PL) luminescence imaging of the panels. The combination of defect detection techniques has been already tested in laboratory [1], [4], although many limitations still need to be addressed in order to obtain image acquisition outdoors and integrate, automate and optimize the imaging system in a drone. The concept of PL/EL in a drone is illustrated in Fig. 1.

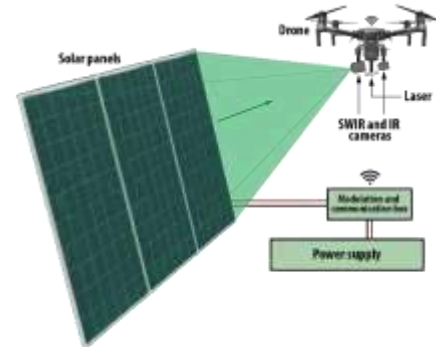

Fig. 1. Concept of automated drone inspection.

In this work, we present the results corresponding to the development of two luminescence-imaging strategies for PV modules defect detection in outdoor conditions, with the aim of choosing the most suitable method for implementation on a drone-based PV plant inspection system.

- [1] M. Köntges *et al.*, "Review of Failures of Photovoltaic Modules," *IEA-Photovoltaic Power Syst. Program.*, pp. 1–140, 2014.
- [2] S. Dotenco *et al.*, "Automatic detection and analysis of photovoltaic modules in aerial infrared imagery," *2016 IEEE Winter Conf. Appl. Comput. Vis.*, pp. 1–9, 2016.
- [3] D. Kint and S. Muñoz-Guerra, "A review on the potential biodegradability of poly(ethylene terephthalate)," *Polym. Int.*, vol. 48, no. 5, pp. 346–352, May 1999.
- [4] S. Johnston and T. Silverman, "Photoluminescence and Electroluminescence Imaging Workstation," *NREL*, 2015.

Cloud-shadow removal for Unmanned Aerial System multispectral imagery based on tensor decomposition methods

Andreas Baum^{1*}, Sheng Wang² Monica Garcia²

¹ Department of Applied Mathematics and Computer Science, Technical University of Denmark

² Department of Environmental Engineering, Technical University of Denmark

*corresponding author: andba@dtu.dk

Multispectral images acquired on board of Unmanned Aerial Systems (UAS) provide unprecedented opportunities to monitor vegetation status and functioning at spatial scales compatible with field instrumentation and field management. UAS such as hexacopters acquire overlapping images that are mosaicked into larger images to produce ortho-photomaps. Frequently, especially in northern latitudes, the images to be mosaicked have been acquired under varying irradiance conditions due to moving clouds that create artifacts in the detected signal unrelated to physical changes in vegetation properties. In order to exploit the full potential of UAS, correction methods should be developed to provide ortho-rectified images that can provide robust estimates of vegetation properties. We applied a Tucker tensor decomposition method to reconstruct images using a four-way factorization scheme. By doing so, this study succeeded to remove the cloud shadow effects and image noise in UAS imagery providing normalized reflectance. The comparison between the corrected and un-corrected images shows a significant improvement for reflectance estimation in the shadow areas. Further, analysis of vegetation indices e.g. normalized difference vegetation index derived from the corrected and un-corrected images also showed improvement. This method could also have the ability to resolve artifacts, such as temporary objects (e.g. humans, tractors etc.) from the vegetation background.

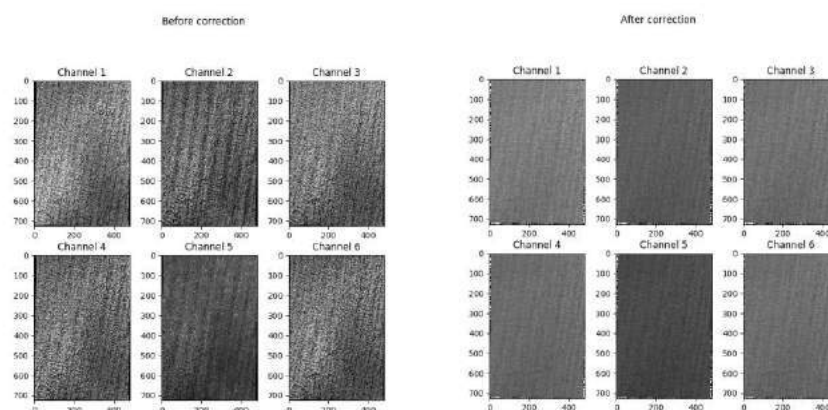

References

Zhang, Xing, Gongjian Wen, and Wei Dai. "A tensor decomposition-based anomaly detection algorithm for hyperspectral image." *IEEE Transactions on Geoscience and Remote Sensing* 54.10 (2016): 5801-5820.

Session

E

Oral Presentations

See session details and schedule on
www.sustain.dtu.dk



Hydrogen assisted catalytic biomass pyrolysis for green fuels

Magnus Zingler Stummann¹, Martin Høj¹, Jostein Gabrielsen², Peter Arendt Jensen¹, Anker Degn Jensen^{1*}

1: DTU Chemical Engineering, Technical University of Denmark, 2800 Kgs. Lyngby (Denmark)

2: Haldor Topsøe A/S, 2800 Kgs. Lyngby (Denmark)

*Corresponding author email: aj@kt.dtu.dk

Fast pyrolysis of biomass produces a high yield of bio-oil through well-established technologies [1]. To utilize this oil as liquid transportation fuel the oxygen content must be reduced from 15-30 wt.% down to <1 wt.%, which increases heating value and stability and decreases acidity [1]. Upgrading bio-oil by hydrodeoxygenation (HDO) is challenged by severe coking upon heating the oil. Alternatively, performing fast pyrolysis in high-pressure hydrogen atmosphere in a fluid bed reactor with a HDO catalyst as bed medium, could immediately stabilize reactive pyrolysis vapors [2]. A schematic diagram for such a process is shown in Figure 1. A simplified bench scale setup has been constructed at DTU Chemical Engineering for proof-of-concept for the continuous conversion of solid biomass to low oxygen, fuel-grade bio-oil.

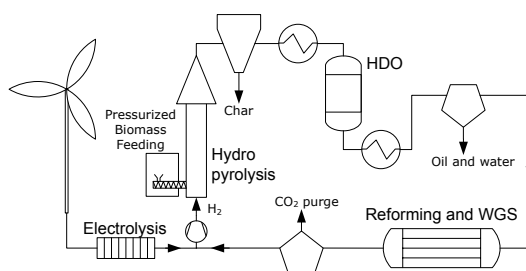

Figure 1: Simplified process diagram including fluid bed catalytic hydro-pyrolysis, char separation, temperature adjustment, vapor phase HDO reactor, cooling, condensation and liquid separation. Steam reforming and water gas shift (WGS) of non-condensable gasses to produce H₂ and wind-powered electrolysis of water to H₂ is envisioned.

Experiments were performed with a sulfided CoMo/MgAl₂O₄ catalyst in the fluid bed reactor and a sulfided NiMo/Al₂O₃ catalyst in the HDO reactor. Hydro-pyrolysis of beech wood was performed at 25 bar with gas composition 470 ppm H₂S, 6 % N₂ balance H₂. The effect of varying the temperature (365-511 °C) and hydrogen pressure (15-35 barg) on the product yield and organic composition was studied. The mass balance closed between 90 and 101 wt. % dry ash free basis (daf). The combined condensed organics and C₄₊ gasses yield varied between 17 and 22 wt. % daf (Figure 2), which corresponds to an energy recovery between 40 and 53 % in the organic product. The yield of non-condensable gasses varied between 24 and 32 wt. % daf and the char yield varied between 9.6 and 18 wt. %. GC simulated distillation showed that the condensed organics consisted of 20-40 vol. % naphtha and 60-80 vol. % diesel. The organics contain 42 to 75 wt. % aromatics, based on GCxGC-FID chromatographic peak area, and the remainder was primarily naphthenes. The condensed organics were essentially oxygen free (<0.001 wt. %) when both reactors were used. Bypassing the HDO reactor increased the oxygen content in the condensed liquid to 1.8 wt. %. In the ongoing work the effect of the choice of catalyst in the fluid bed is investigated and a combined organic and C₄₊ gas yield of 25 wt.% daf has been obtained. The results show that catalytic hydro-pyrolysis may be a viable way to process solid biomass into liquid and gaseous hydrocarbon fuels.

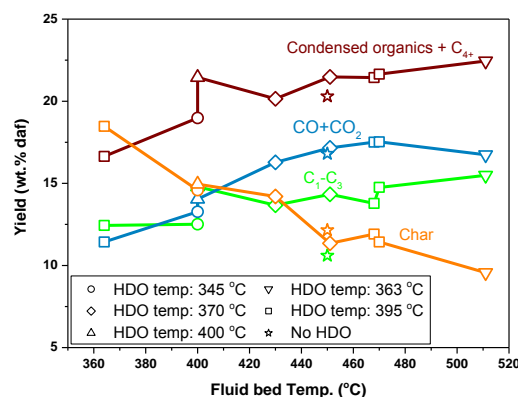

Figure 2: Effect of the fluid bed temperature.

[1] A. V. Bridgewater, *Therm. Sci.* 8 (2004) 21.

[2] T.L. Marker, L.G. Felix, M.B. Linck, M.J. Roberts, *Environ. Prog. Sustain. Energy* 31 (2012) 191.

On the importance of including a life cycle perspective in assessing the environmental performances of renewable energies

Monia Niero^{1*}, Stig I. Olsen, Alexis Laurent¹

1: Division for Quantitative Sustainability Assessment (QSA); DTU Management Engineering

*Corresponding author email: monni@dtu.dk

Cradle-to-Cradle® (C2C) is one of the key frameworks that lead to the development of the circular economy concept. The C2C design framework is based on three key principles: i) “Waste equals food”, i.e. everything is a resource for something else; ii) “Using current solar income”, i.e. energy should be renewable, and iii) “Celebrate diversity”, i.e. there is no “one-size-fits-all” solution. To allow companies to monitor and market their progress towards the C2C vision, a certification program (Cradle to Cradle Certified™ Product Standard) was established. It includes a series of requirements divided into five quality criteria, being scored on a 5-grade scaling system (from basic to platinum). Most of the efforts in the implementation of the circular economy concept have focused on promoting the shift from a waste paradigm to a resource one (i.e. first C2C principle), and the role of energy systems in the circular economy debate has been largely overlooked. The second C2C principle is translated in the C2C certification program by the quality criterion “Renewable Energy and Carbon Management” (RE&CM), which includes a partial life cycle perspective. For all the grades but platinum in the scaling system, indeed energy use only at the manufacturing stage of a product is considered, thus leaving out the energy use during raw materials extraction, product use and end-of-life.

The aim of the present research was to provide decision-makers in industry with a demonstration of the benefits of introducing a life cycle perspective in the C2C certification program with respect to the “solar energy income” principle [1]. We considered the case of aluminium beverage cans in the UK market and compared different scenarios: 1) the current Al can system, (2) the Al can system with 50%, or 100% use of renewable energy in the manufacturing stage (reflecting C2C certification requirement for gold and platinum for the RE&CM criterion), and (3) the Al can system with consistent use of renewable energy throughout the life cycle, considering different aluminium-producing countries (China and Europe).

Our results show that compliance with the current RE&CM certification framework offers significant reduction for climate change, but negligible reductions for other environmental impacts (e.g., particulate matter and acidification). However, increasing the share of renewable energy in the primary Al production from a full life cycle perspective can greatly increase the environmental benefits brought up by the C2C certification not only for climate change, but also for the broader range of impact categories [1].

References

[1] Niero M., Olsen S.I., Laurent A. (2017) Renewable energy and carbon management in the Cradle-to-Cradle certification: Limitations and opportunities. *Journal of Industrial Ecology* DOI: 10.1111/jiec.12594



Perspectives with Electrolysis and Electrification for Making Sustainable Fuels and Chemicals

Peter Blennow*

Haldor Topsoe A/S, Haldor Topsøes Allé 1, DK-2800, Kgs. Lyngby

*Corresponding author email: pebl@topsoe.com

Many of the chemicals and materials that we use and produce today is either directly or indirectly carbon based, and from fossil fuels. As the world is trying to decrease the fossil fuel foot print, a need for alternative carbon sources and energy production, storage and transportation is needed. This presentation will within the perspective of electrolysis and by utilizing the foundation of Haldor Topsoe's eCOs technology for on-site CO production, discuss how the combination of renewable electricity and a number of CO₂ sources can be utilized to produce sustainable gasses, fuels, and chemicals.

Energy Retrofitting Measures in Buildings: Optimization Tool

Mohamad Kharseh*¹, Holger Wallbaum²

1-2: Chalmers University of Technology

*Corresponding author email: mohamad.kharseh@chalmers.se

In European Union about 40% of the total energy consumption consumed in the building sector. Space heating and cooling systems are responsible for more than two-thirds of energy used in the buildings. The external envelope of the buildings (i.e., windows, walls, roof, and floor) plays the major role in determination of the space heating or cooling loads. Therefore, the current building regulations aim at making the thermal losses through the building envelope as small as possible. Unfortunately, 72% of residential dwellings in the EU were built before 1972, namely, were built to the thermal performance standards lower than the current standards which are imposed under current building regulations. Thus, refurbishment of the old building is a curtail factor to fulfill the target of EU in reducing the energy consumption. In another word, the most substantial potential for saving energy lies on renovation and upgrading the old buildings to modern energy standard.

Lately, reducing thermal load of existing buildings via employing different energy retrofitting measures and implementing renewable energy resources have the objective of considerable number of study and ongoing projects. However, in most cases, there is a limit of the budget for such refurbishment. Therefore, we are, as researchers working in DREEM project funded by EU, have been working on developing a computer model that assists investors and decision makers in selecting the desired energy retrofitting measures in which the maximum reduction in energy demand of a building can be achieved for a given budget.



Intermittent provision of H₂ and CO₂ in up-flow reactors for ex-situ biogas upgrading

Natalia Alfaro^{1,2}, Panagiotis G. Kougias*¹, Laura Treu¹, María Fdz-Polanco², Fernando Fdz-Polanco², Irini Angelidaki¹

1: Department of Environmental Engineering, Technical University of Denmark, Kgs. Lyngby, Denmark.

2: Department of Chemical Engineering and Environmental Technology, University of Valladolid, Valladolid, Spain.

*Corresponding author e-mail: panak@env.dtu.dk

CO₂ fixation by means of its conversion with H₂ to bioCH₄ is gaining attention in the actual context of renewable energies implementation in the EU countries and particularly in Denmark. BioCH₄ can be injected into natural gas grids or employed as fuel for vehicles. Moreover, H₂ generation from water electrolysis using off-peak electricity surplus from wind power can solve the limitations of variable wind power production and electricity storage. Therefore, the coupling of biogas production from the anaerobic digestion with the exploitation of H₂ that is generated due to excess wind energy is an effective method for bioenergy production.

Biological biogas upgrading creates a unique synergy of renewable energy sources without the use of chemical products or extreme operating conditions. Thus, it constitutes a cheaper alternative technology moving towards cleaner energy production and utilization and environment conservation. The supply of H₂ and a CO₂ (or biogas) to an exclusively methanogenic bioreactor rich in hydrogenotrophic methanogens is called as ex-situ biogas upgrading. Due to the fact that H₂ assisted biogas upgrading technology is based on the surplus of electricity generated by wind power, the system should be resilient to variable weather conditions and thus to different input H₂ flow rates.

The aim of the study is to evaluate the intermittent addition of H₂ for ex-situ biogas upgrading in order to evaluate the dynamicity of the process. The experimental setup includes 3 up-flow reactors fed with H₂ and CO₂ in the normal feeding periods and different H₂ stop-feeding periods ranging from 1 up to 3 weeks. The dispersion of gasses in the reactors are performed using stainless steel diffusers combined with ceramic sponges. Microbial communities populating the upgrading reactors are being studied during the different experimental stages to elucidate their plasticity against the lack of H₂.

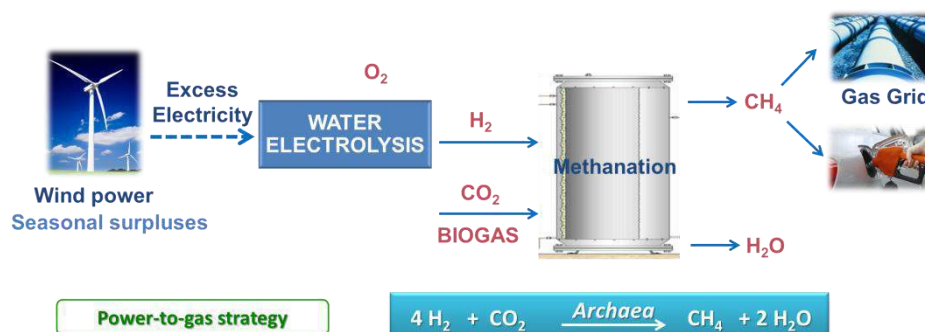

References:

- P.G. Kougias et al., 2017. Ex-situ biogas upgrading and enhancement in different reactor systems. *Bioresource Technology*. 225, 429-437.
- Ilaria Bassani, 2017. PhD Thesis - Technical University of Denmark, DTU Environment.
- I. Díaz et al., 2015. A feasibility study on the bioconversion of CO₂ and H₂ to biomethane by gas sparging through polymeric membranes. *Bioresource Technology*. 185, 246-253.

Session

E

Laptop Presentations

See session details and schedule on
www.sustain.dtu.dk



Reliability of electronics to humidity-related failures

Salil Joshy*, Morten Jellesen, Rajan Ambat,

Technical university of Denmark, Kgs. Lyngby 2800

*Corresponding author email: saljos@mek.dtu.dk

The quest for sustainable energy sources have led us to renewable sources of energy like wind, solar, tidal, fuel cells, geothermal energy etc. The energy produced from these sources have to be processed before feeding into the electrical grid. The processing of raw electric power produced by solar cells, wind turbines, fuel cells etc. have to be done using power electronic converters. Due to the currently ongoing move towards sustainable energy technologies, more and more power converters would find application in power production, transmission and processing. An example of this is the solid-state transformer (SST) which can provide voltage regulation, reactive power compensation, dc-sourced renewable integration, and communication capabilities, in addition to the traditional step-up/step-down functionality of a transformer [1].

Humidity related failures contribute around 20% to the total failures in electronics [2]. The failure mechanism due to humidity in electronics is the combined interaction of humidity and temperature on materials comprising the components and printed circuit board assemblies (PCBA) used in electronic control units (ECUs). High humidity if present inside the electronic enclosures can condense on PCBAs and components under certain conditions causing short circuit currents. Another mechanism which can cause short-circuit failures is electrochemical migration [3]. Failures can also result from leakage currents on PCBAs and components due to low-impedance paths created by adsorbed microscopic layer of water. The magnitude of the leakage current is amplified by the presence of hygroscopic ionic contamination left behind on the PCBAs from the PCB manufacturing and component assembly process.

This work demonstrates an ongoing research that seeks to:

- 1) Study how humidity accumulate inside electronics enclosures under constant and cycling conditions of temperature.
- 2) To predict humidity related issues in a given circuit design for a certain humidity and contamination concentration on PCB.
- 3) To predict humidity accumulation and condensation on PCBA for a particular climatic profile of relative humidity (RH) and temperature.
- 4) To study methods to prevent condensation and high humidity inside electronic enclosures.
The methods studied include preferential condensation to remove excess humidity and heating to reduce the RH.

References

- [1] K. Mainali, A. Tripathi, S. Madhusoodhanan, A. Kadavelugu, D. Patel, S. Hazra, K. Hatua, S. Bhattacharya, "A Transformerless Intelligent Power Substation: A three-phase SST enabled by a 15-kV SiC IGBT", IEEE Power Electronics Magazine, vol. 2, Issue 3, pp. 31-43, 2015
- [2] C. Sintamarean, F. Blaabjerg, H. Wang, Y. Yang, "Real field mission profile oriented design of a SiC-based PV-inverter application", IEEE Transactions on Industry Applications, Vol. 50, Issue 6, pp. 4082-4089, 2014
- [3] D. Minzari, M. S. Jellesen, P. Moller and R. Ambat, "On the electrochemical migration of tin in electronics," Corrosion science, Vol. 53, Issue 10, pp. 3366--3379, 2011.

Session

E

Poster Presentations

See session details and schedule on
www.sustain.dtu.dk



Bottom-up energy service solutions and long term system planning

Per Nørgaard¹

1: DTU Center for Electric Power & Energy, pern@elektro.dtu.dk

Customers don't request energy – they request energy services. Customers don't request heat or cold – they request comfort! Customers don't request transport – they request mobility! The sustainable solution to provide the requested indoor comfort is obtained by a combination of the design of energy efficient buildings, smart energy efficient and energy flexible solutions and an appropriate energy system. And the sustainable solution to provide the requested mobility is obtained by a combination of energy efficient urban planning, and smart energy efficient and energy flexible transport solutions.

Today's investments in energy solutions and systems will bind our opportunities for the next decades. Examples: The natural gas network in Denmark, the district heat system in Denmark, the highways for cars and trucks, and the wired electrification of the trains. It is therefore crucial that tomorrow's investments contribute to a sustainable solution. For that we need a picture of the energy services requested in the future, and for the energy solutions and systems that best fit the energy services. In the future, our buildings will only need energy for the electric appliances and for the hot domestic water, and they will only exchange electricity with the public electricity grid. Part of the transport sector will be electric. The main energy sources in Denmark will be solar and wind. The only large scale grid will be the electricity grid. Local thermal grids will serve as heat sink and source. The energy system will be smart, integrated and distributed. The energy system will consist of local energy systems at all scales, with local energy trading and weekly connected to their neighbours. All components connected to the grids will contribute with energy flexibility and other energy system services. All future solutions and investments should be based on and contribute to the development of this picture.

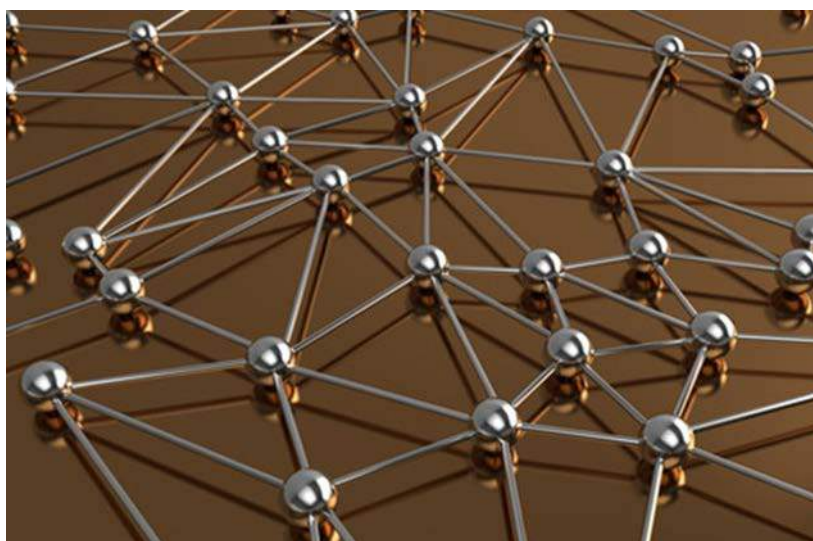

Multi-disciplinary optimization of organic Rankine cycle power systems

Fredrik Haglind¹, Muhammad Imran¹, Maria E. Mondejar^{*1}, Ji Zhang¹, Xiaowei Zhu¹

1: Technical University of Denmark, Building 403, 2800 Kongens Lyngby, Denmark

*Corresponding author email: maemmo@mek.dtu.dk

The organic Rankine cycle technology is an efficient way of converting the low grade heat, from renewable energy or industrial waste, into electricity. This technology is expected to play a substantial role in the future energy generation system, as it will contribute to extend the use of renewable resources and increase the energy efficiency of industrial processes and transport, thus reducing the CO₂ emissions and the consumption of fossil fuels.

Although the ORC technology is currently used in geothermal and biomass plants, and in industrial waste heat recovery, it faces a number of challenges that hinder its expansion to a wider number of applications. For instance, highly variable heat sources such as in the case of internal combustion engines may require an improved control strategy that can handle the transients during operation. Also, recent regulations that limit the use of working fluids with high global warming potential impose the search of alternative fluids that meet both thermodynamic and environmental requirements. Furthermore, the technology needs to be more competitive by increasing the energy conversion efficiency and reducing the volume to power ratio.

Here we aim at presenting the work carried out at our group, where an interdisciplinary approach, with both experimental and numerical research, is followed to overcome the current challenges of the organic Rankine cycle technology. The project DYNCON-ORC aims at developing a predictive control strategy for mini-scale units to be used in heavy-duty vehicles. The project NanoORC aims at developing models for the prediction of the thermophysical and transport properties of innovative working fluids. A H.C.-Ørsted project investigates experimentally the heat transfer of zeotropic mixtures in plate heat exchangers to contribute to the design of more efficient organic Rankine cycle units. Finally, the project MicroPHE focuses on the numerical optimization of microstructure enhanced plate heat exchangers in order to reduce the heat transfer equipment costs.

The on-going and future work developed within these projects, supported all by European funding, will provide essential knowledge to the scientific and industrial communities, and will contribute to build a sustainable future based on an efficient and clean exploitation of the energy resources.

Acclimation of ammonia tolerant methanogenic consortia using different bioreactor types

E. Mancini¹, I. A. Fotidis*¹, H. Tian¹, I. Angelidaki¹

1: Department of Environmental Engineering, Technical University of Denmark, Bygningstorvet Bygning 115, DK-2800 Kgs. Lyngby, Denmark

*Corresponding author email: ioanf@env.dtu.dk

Ammonia is the most common inhibitor of anaerobic digestion (AD) process, triggering suboptimal exploitation of the biogas potential of the feedstocks, resulting to significant economic losses for the biogas plants (Fotidis et al., 2013). Bioaugmentation with ammonia tolerant methanogens was proposed as a solution to overcome ammonia inhibition. However, there is still the need to establish appropriate technologies to generate ammonia tolerant methanogens. In the current study, three reactor types (i.e. batch, fed-batch and continuous stirred-tank reactors (CSTR)) operated at mesophilic (37°C) and thermophilic (55°C) conditions, were assessed as means for generation of acclimatized ammonia tolerant methanogens. The technologies were evaluated based on their methane production efficiency, incubation time and final TAN/FAN (total ammonium nitrogen/free ammonia nitrogen) levels. Overall, fed-batch cultivation was clearly the most efficient acclimation method compared to batch and CSTR methods. Specifically, by saving incubation time up to 150% (or up to 94 days), fed-batch reactors were acclimatized to nearly twofold higher FAN levels (549 and 1633 mg NH₃-N L⁻¹ for mesophilic and thermophilic conditions, respectively) compared to batch method, with the same efficiency (>83%). At the same time, CSTR reactors were inhibited at lower ammonia levels (< 4.6 g NH₄⁺-N L⁻¹) reaching only 30% of the theoretical production. The reduced growth rate of the microorganism, caused by ammonia toxicity, led to their washout. The higher performance of the fed-batch compared with CSTR and batch reactors is attributed to: the absence of washout for the former and the relatively stable microorganism growth for the latest (Fynn & Whitmore, 1984). In fed-batch in fact, the growth is controlled by the exponential feeding strategy (Ding & Tan, 2006).

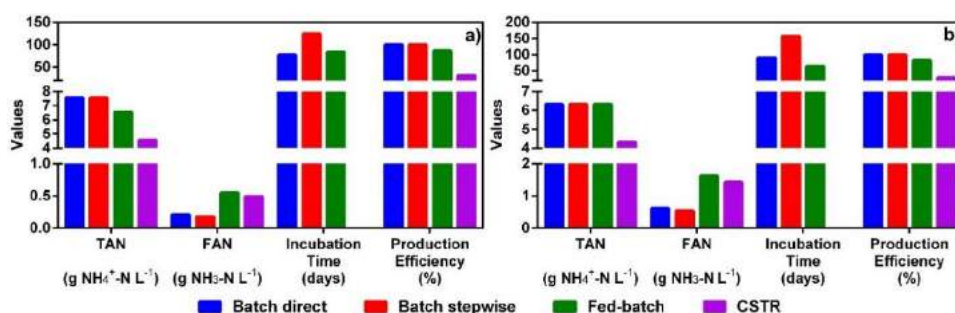

Figure 1. The acclimation methods for a) mesophilic and b) thermophilic inocula

Ding, S., Tan, T. 2006. L-lactic acid production by *Lactobacillus casei* fermentation using different fed-batch feeding strategies. *Process Biochemistry*, **41**(6), 1451-1454.

Fotidis, I.A., Karakashev, D., Angelidaki, I. 2013. The dominant acetate degradation pathway/methanogenic composition in full-scale anaerobic digesters operating under different ammonia levels. *International Journal of Environmental Science and Technology*, **11**(7), 2087-2094.

Fynn, G.H., Whitmore, T.N. 1984. Retention of methanogens in colonised reticulated polyurethane foam biomass support particle. *Biothechnology Letters*, **6**(2), 81-86.

Nanoscale engineering of 3D graphene foams for enzyme immobilization and enhanced bioelectrocatalysis

Fei Shen[†], Jingdong Zhang^{†*}, Jens Ulstrup[†], Lars Henrik Østergaard[‡], Qijin Chi^{†*}

[†] NanoChemistry Group, Technical University of Denmark, DK-2800 Kongens Lyngby, Denmark

[‡] Novozymes A/S, Krogshøjvej 36, DK-2880 Bagsværd, Denmark

* Corresponding author email: jz@kemi.dtu.dk; cq@kemi.dtu.dk

Immobilization of enzymes on a solid support is an essential step for many crucial applications associated with biosensing devices, biofuel cells and industrial catalysis. To this end, retaining the native structures and biocatalytic activity of enzymes upon immobilization is required but has consistently posed challenges to match practical applications. Among all possible considerations, the choice of material type and structures of a solid support is a key factor. Graphene based nanomaterials have offered newly emerging opportunities for the immobilization of various enzymes, mainly because of their large specific surface area, high electrical conductivity, good mechanical strength, tunable flexibility and biological compatibility^[1].

In this study, we have attempted to use three-dimensional graphene foams (3D-GFs) as a flexible supporting material for accommodating *Rhizoctonia solani* laccase (Rsl). Biotin and neutravidin were used as the linking molecules for covalent attachment of laccase onto the 3D-GFs (**Figure 1, left**). The biocatalytic activity of the immobilized enzyme towards oxygen reduction reaction (ORR) was systematically studied using 2,2'-azinobis(3-ethylbenzothiazoline-6-sulfonate) diammonium salt (ABTS) as an electron-transfer mediator (**Figure 1, right**). The results suggest that the newly engineered bioelectrode holds promising potential for construction of enzymatic biofuel cells (EBFCS).

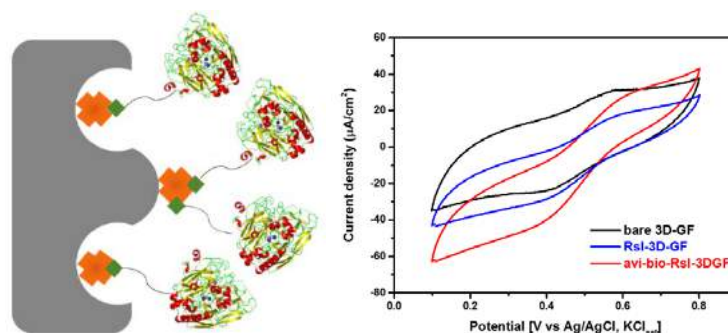

Figure 1. Schematic illustration of covalent immobilization of laccase on 3D graphene foam and its electrochemical behavior. Not drawn to scale.

References

[1] D. R. Dreyer, *et al.*, *Chem. Soc. Rev.* **39**, 228-240 (2010).

Acknowledgments

This PhD project is supported by the YDUN project (DFF 4093-00297), China Scholarship Council (CSC 201506170059) and DTU Chemistry. We thank Novozymes for providing the samples of laccase.

Surface characterization of coated cathodes with lithium phosphorous oxynitride thin film for all-solid-state Li-S batteries

Jessica Lefevr*, Didier Blanchard, Eugen Stamate

Department of Energy Conversion and Storage, Technical University of Denmark,

Frederiksborgvej 399, DK-4000 Roskilde, Denmark.

jefef@dtu.dk

Increasing use of systems based on renewable energy sources has made the battery research an important area. Li-ion batteries are commonly used in electronics devices but require many improvements to obtain longer life-time and higher energy densities. Various alternatives to current state-of-art lithium-ion batteries exist. Among them are lithium-sulfur solid-state batteries; solid electrolytes have higher stability when compared to liquid electrolytes, with no risks of vaporization and leakage while sulfur cathodes have high theoretical energy density. LiBH_4 is a promising material for solid-state batteries as it is lightweight and stable electrochemically at least up to 6 V. We have successfully built and cycled solid-state lithium-sulphur batteries based on nanoconfined LiBH_4 . To protect the cathode from forming an interface with the solid electrolyte we have deposited a thin film of lithium phosphorous oxynitride (LiPON) by magnetron sputtering (see figure 1 and 2).

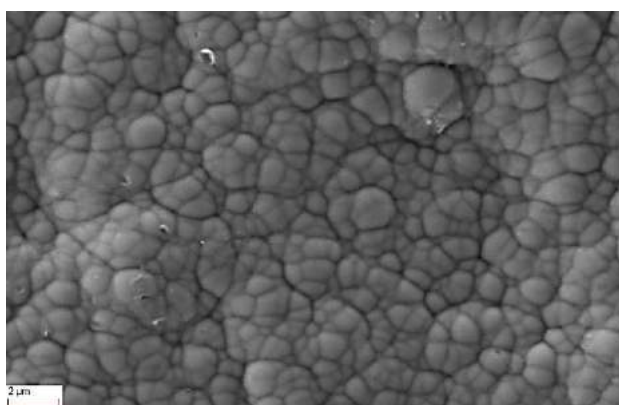

Figure 1. SEM image of the surface of cathodes covered with LiPON thin films (1 μm)

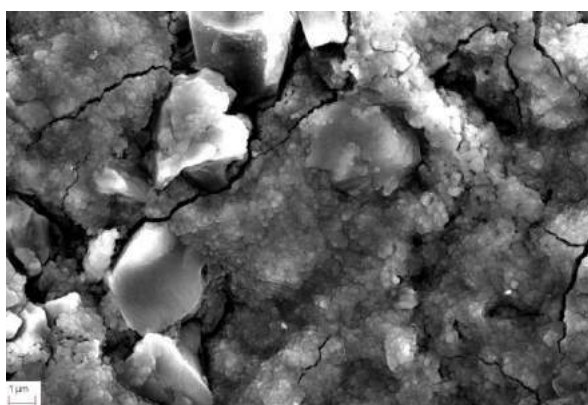

Figure 2. SEM image of the surface of cathodes covered with LiPON thin films (100 nm)

LiPON has high electrochemical stability window (0 - 5.5V) vs Li and is stable against Li metal. It is an acceptable Li-ion conductor ($\sim 2 \cdot 10^{-6} \text{ mS cm}^{-1}$) and has low electron conductivity ($\sim 8 \cdot 10^{-14} \text{ S cm}^{-1}$) at 25°C, furthermore the films are flexible and do not crack, even during the swelling of the cathode [2]. We have deposited LiPON films of 1 μm and 100 nm for protection of cathodes and 1 μm films show uniform surfaces while 100 nm films show rough surface with distinct sulphur particles. We have built and cycled solid-state lithium-sulphur batteries using 1 μm LiPON protected cathodes. The batteries show no electrochemical parasitic reactions, otherwise present and giving capacity two times larger than higher than the theoretical ones during the first discharge. Furthermore, the batteries exhibit better capacity retention during charge-discharge cycling compared to batteries with non-coated cathodes.

References

1. D. Blanchard, A. Nale, D. Sveinbjörnsson, T. M. Eggenhuisen, M. H. W. Verkuijlen, Suwarno, T. Vegge, A. P. M. Kentgens, P. E. de Jongh, (2015) Nanoconfined LiBH_4 as a Fast Lithium Ion Conductor. *Adv. Funct. Mater.* 25, 184 (2015).
2. A. Christiansen, E. Stamate, K. Thyden, R. Younesi, P. Holtappels (2014) Plasma properties during magnetron sputtering of lithium phosphorous oxynitride thin films. *Journal of Power Sources* 273 (2015) 863-872.

Spray-coated $\text{Cu}_2\text{ZnSnS}_4$ thin films for large-scale photovoltaic applications

Sara Engberg^{*1}, Swathi Murthy², Simón López Mariño³, Ole Hansen³, Guggi Kofod², and Jørgen Schou¹

1: DTU Fotonik, 2: Inmold, 3: DTU Nanotech.

*Corresponding author email: sleen@fotonik.dtu.dk

The kesterite material, $\text{Cu}_2\text{ZnSnS}_4$ (CZTS), has in the preceding ten years been investigated and developed as a new Earth-abundant material for solar cells. The interest in this inorganic semiconductor originates in its optimal energy band gap of approx. 1.5 eV, high absorption coefficient, and the high material abundance and low toxicity of all elements included. The current challenges are related to unavoidable antisite disordering stemming from the chemical similarity of the cations, which causes bulk defects and lowers the open-circuit voltage detrimentally. This, however, did not restrict the “cousin”-material, CuInGaSe_2 (CIGS), which is currently one of the main thin-film photovoltaic (PV) technologies on the market.

In this work, CZTS thin films have been fabricated by solution-processing, which allows relatively fast and inexpensive deposition when compared to vacuum-processed films. The nanoparticles are synthesized by the hot-injection method by mixing targeted ratios of metal salts with sulfur in diethylene glycol, resulting in a phase-pure CZTS material [1]. Inks are formulated by dispersing the particles in ethanol and water using a suitable dispersing agent. The solvents used allow that alkali metal chloride salts can also be dissolved in controllable amounts, which we have found enhances grain growth in the films during the subsequent annealing step.

A Sono-tek spray-coating system with ultrasonic atomization is used. We investigate the effect of ink concentration, and spray-coating conditions, including spray power, flow rate from syringe pump, and time between consecutive spray layers. The films are annealed in a tube furnace, and to avoid decomposing the material into secondary phases, a graphite box is used to enable an overpressure of sulfur and tin-sulfide. The annealed, spray-coated films are characterized by scanning electron microscopy (SEM), optical microscopy, and Dektak profilometry.

[1] Naghmeh Mirbagheri, Sara Engberg, Andrea Crovetto, Søren Simonsen, Ole Hansen, Yeng Ming Lam, and Jørgen Schou, *Synthesis of ligand-free CZTS nanoparticles via a facile hot injection route*, *Nanotechnology*, 27 (2016).

Geotechnical challenges for establishing an Aquifer Thermal Energy Storage (ATES) in the greater Copenhagen area (Zealand, Denmark).

L. Paci^{1*}, I. Rocchi¹, S.N: Sørensen² and I.L. Fabricius¹

1: Technical University of Denmark, DTU-BYG, Nordvej Building 119 2800 Kgs. Lyngby, DENMARK

2: Enopsol, Diplomvej 373, 2800 Kgs. Lyngby, DENMARK

*Corresponding author email: laupa@byg.dtu.dk

Underground Thermal Energy Storage (in particular Aquifer Thermal Energy Storage, ATES) systems are a key point to guarantee the successful integration of renewable energy (e.g. solar energy and waste-to-energy) in a smart energy grid connected to the District Heating (DH). The lack of geotechnical data, the limited and poor quality of the geophysical dataset represent the main obstacle to evaluate the potential of such technologies. The available geotechnical information target the first 50m of the subsurface, i.e. shallow and cold aquifers (natural groundwater temperature around 10°C) that if used as thermal storage will limit the potential of UTES technologies while deeper aquifers (500-800mbgl) have a higher natural water temperature (around 30°C) and no risks of interfering with the drinking water reservoirs. In the greater Copenhagen area, the potential deep ATES target is the Upper Cretaceous limestones (Chalk Group), a carbonate rock consisting mainly of the remains of planktonic algae and other pelagic organisms. Figure 1 shows some of the few data available regarding the geotechnical properties of limestones in Zealand. The elastic modulus of the Copenhagen Limestone (Cenozoic part of Chalk Group) does not show a specific trend and covers a wide range from hundreds of MPa up to 50GPa, while the elastic modulus based on deep well log data presents an overall increase of the elastic modulus with depth. To overcome the present insufficient geotechnical information, a virtual deep pilot based on the shallow ATES under construction at the Bispebjerg Hospital (Copenhagen), will be used to assess the best integration between ATES and renewable energies, focusing on identifying the long term behaviour of the system based on thermo-hydro-mechanical testing. These aspects are crucial to enable exploitation of the limestone at DH temperatures (40-90°C).

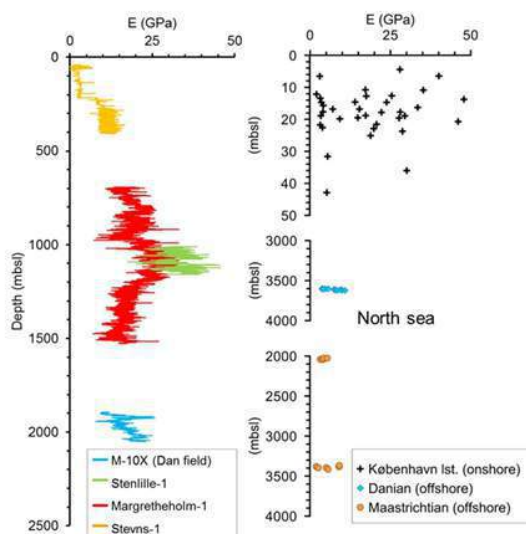

Figure 1 Elastic characteristics of Chalk Group.

Can Polynuclear Metal Clusters Behave as "Extended" Organometallic Complexes?

Martin Nielsen^{1,2} and Theodore A. Betley²

¹ DTU Chemistry, Technical University of Denmark

² Department of Chemistry and Chemical Biology, Harvard University

In the past few years, our group has demonstrated the synthesis of the hexanuclear iron cluster (HL)₂Fe₆ and its redox potential, which spans at least 7 redox steps. The hexanuclear core comprises an octahedral structure with an iron metal positioned on each of the six vertices, each possessing one vacant coordination site directed outwards from the center of the Fe₆ octahedral. The cluster HOMO is a triply degenerate orbital of t_{1u} symmetry, approximating three p-orbitals equally distributed over two iron centres *trans* to each other. This set up the possibility to perform chemistry on the cluster much alike what we know from classic organometallic chemistry, and a range of questions needs to be addressed: Does the cluster undergo oxidative addition and would it be *trans* and/or *cis* selective? What is the mechanism? In principle, up to three consecutive oxidative additions are possible; can we control that? Is the reverse, reductive elimination, feasible? Are there *cis/trans* effects over the core such that e.g. an iron centre would be influenced by the ligation of its *trans* iron partner?

We strive to answer these questions, and our findings this far will be presented.

Session

F

Oral Presentations

See session details and schedule on
www.sustain.dtu.dk





Critical review of life cycle assessments conducted on aquaculture systems: identification of environmental improvements

Florence Bohnes^{1*}, Michael Z. Hauschild¹, Jørgen Schlundt² and Alexis Laurent¹.

1: Division for Quantitative Sustainability Assessment (QSA), DTU Management, DK.

2: Food Technology Centre (NAFTEC), Nanyang Technological University, Singapore.

*Corresponding author: flbo@dtu.dk

Answering the growing demand of food for human consumption, the aquaculture industry has grown considerably for the past decades and is expected to expand further in the future. It is thus critical to ensure that the development of this sector is associated with as low environmental impacts as possible. Even though it is often presented as the most environmentally sustainable source of proteins, seafood farming is associated with multiple environmental impacts such as climate change, eutrophication or biodiversity loss. A widely used tool to assess environmental sustainability of food products is life cycle assessment (LCA), and it has been applied to aquaculture systems in multiple studies over the last 15 years. What can we learn from this pool of LCA studies that will help system developers and decision makers reduce the impacts from the aquaculture sector? Which general trends can be identified to enable drawing recommendations about preferable system characteristics? To answer these questions, we performed a critical review of 65 LCA studies of aquaculture systems. We used meta-level statistical analysis to compare their findings and conclusions with respect to the different types of aquaculture systems. We found that the type of technology used is highly influential on the environmental impacts, and that recirculating aquaculture systems tend to have lower eutrophication impacts than other technologies but higher impacts for other categories of impact. High-intensity systems tend to be associated with high global impacts but lower regional and local impacts, even though some modern and highly optimized systems stand out with low impacts in all impact categories. Generally, polyculture, in particular integrated multi-trophic aquaculture, seems to have lower environmental impacts than monoculture. The choice of aquafeed was also found to be extremely important, as it usually drives the majority of environmental impacts except eutrophication. It should be noted that certain management practices that might impact negatively in LCA could result in positive outcome in other areas, such as lowering health risk through improving water hygiene and avoiding antimicrobial use. Based on these findings, we recommend stakeholders to focus on reducing impacts from the feed and give preference to the technologies highlighted in the above, duly taking into account local conditions.



Nitrogen-to-protein conversion factor of seaweed varies with season

G.S. Marinho ¹, S.L. Holdt ^{*2}

1: DTU Food, The National Food Institute, Technical University of Denmark, DK-2800 Kgs. Lyngby, Denmark

*Corresponding author email: suho@fod.dtu.dk

This paper presents and evaluates the seasonal nitrogen budget of the sugarkelp, *Saccharina latissima* and discusses the importance of more specific nitrogen-to-protein conversion factors compared to commonly used factors. There has however recently been an effort to establish “a worldwide” nitrogen-to-protein conversion factors specific for seaweeds, as the traditional conversion factor of 6.25 overestimates their protein content [1,2], but without also considering possible seasonal variation of this conversion. This has also been addressed in the present study. The seaweed biomass was collected bi-monthly from commercially farmed *S. latissima* on droppers outside Horsens Fjord in Denmark from May 2013 to May 2014. Triplicates (each averaged by 10 specimen) were freeze dried and stored frozen until further analyses which included: Kjeldahl-N, amino acid composition by hydrolysis and determined by liquid chromatography with a mass spectrometry detector, and nitrate (NO₃⁻) concentration determined by ion chromatography. The total protein concentration of *S. latissima* varied from averages of 5.3% in July to 18.3% of dw in Nov/Jan when using the more recent nitrogen-to-protein factor of 5.38 [1]. However, the total protein concentration is only be 1.8% protein in May and 11.8% protein per dw biomass if estimated by summarizing amino acids. Comparing these data, the amino acids explained only ~23% of the protein content (by conversion factor) in the summer (May) and 97% during winter (Nov). The nitrate concentration of the seaweed varied significantly by season from zero in summer (between May and September) to 6.37% of dw biomass in November. The high nitrate biomass concentration due to higher seawater nitrate availability during the dark cold periods of winter in Denmark. The low nutrient availability during summer is most likely due to the high nutrient assimilation from microalgae, and remineralization and availability for e.g. macroalgae during winter. This study shows specific seasonal nitrogen-to-protein conversion factors, ranging from 0.96 in March 2014 to 4.57 in Nov 2013 with a yearly average of 2.49±1.07. This is substantially less than the traditional 6.25, the newer 5.38 [1] and the recently proposed 5.0 [2] analysed systematically from empiric data. These findings show the importance of developing more specific nitrogen-to-protein conversion factors in order not to overestimate protein concentrations, and thereby fool ourselves and others e.g. customers and consumers.

[1] Lourenço SO, Barbarino E, De-Paula JC, Pereira LODS, Marquez UM (2002) Amino acid composition, protein content and calculation of nitrogen-to-protein conversion factors for 19 tropical seaweeds. *Phycol Res* 50:233–241

[2] Angell AR, Mata L, de Nys R, Paul NA (2016) The protein content of seaweeds: a universal nitrogen-to-protein conversion factor of five, *J Appl Phycol* 28:511–524

Protein from green biomass as a food resource

Daniel Stender Nørgaard, Mikkel Duvier Stærmose, Claus Bang-Bertelsen and Peter Ruhdal Jensen

Research Group for Microbial Biotechnology and Biorefining

National Food Institute, Technical University of Denmark, 2800 Kgs. Lyngby, Denmark

*Corresponding author email: perj@food.dtu.dk

The world population growth and the protein demand that follows, requires new alternatives to meat. We are adjusting to fully utilise our planets resources and in this context biorefining plays a critical role. The Danish agricultural sector has established methods for utilisation of protein from green biomass, as an alternative to soy protein in pigs feed. The prior research has shown that protein extracts that are derived from green biomass, has a very favourable amino acid profile, similar to that of milk and meat. Compared to other protein resources, grass is much more sustainable, and in a food ingredient perspective, it is also a very cheap resource. The nutritional properties, sustainability and availability perspectives, makes the green protein a good candidate as future alternative protein resource, but there are challenges related to off flavours and other properties when used as food ingredient. We have very promising results on how we can utilise a fraction from the green biomass feedstock production, as a food ingredient. By adding extra processing steps, such as solvent extraction and heat treatment, the extracts can be used successfully for protein enrichment in e.g. energy rich snack products.

Our research group collaborate with AU and relevant industrial partners, to develop a cost-effective and sustainable production of high quality grass protein extracts, that can be used as protein supplement in a wide range of food products.



Humidification of fresh produce: evaluating potential for reducing post-harvest losses and environmental impacts of food supply chains

Serena Fabbri*¹, Stig Irving Olsen¹, Mikołaj Owsianiak¹

1: Division for Quantitative Sustainability Assessment (QSA), DTU Management Engineering

*Corresponding author email: serf@dtu.dk

Reducing food losses along supply chains has become a priority in many countries, as it contributes to food security and plays an important role in reducing environmental impacts of food consumption stemming from agricultural production. The humidification of fresh harvested fruit and vegetables is one of the technologies that can reduce food losses by improving the efficiency of refrigerated storage in cold rooms, during transport and retailing. Humidifiers release a fine water mist on fresh produce, thereby maintaining an optimum humidity levels and cool temperatures of the air surrounding the produce. Biological deterioration and moisture loss are reduced and shelf-life of the produce extended, leading to an overall reduction of food losses. While the technology is expected to bring environmental benefits by reducing post-harvest losses, the environmental burden of production and operation of the humidifiers should also be considered in assessing the overall environmental performance of humidification systems. Therefore, life cycle assessment (LCA) was employed to evaluate the environmental performance of humidification technology as a potential technology to reduce post-harvest losses of fruits and vegetables, taking into account these potential trade-offs. To do so, supply chains of selected produce were analysed, from agricultural production, via transportation and distribution to the consumers, including food losses disposal.

When comparing conventional supply chains with the humidification-based, it was found that the humidification technology reduces many relevant environmental impacts, including climate change. The improvements are an effect of the reduction of post-harvest food losses caused by the technology, as this implies lower environmental impacts mainly from agriculture (due to reduced need for production). This means that the benefits from reducing food losses generally counterbalance the burdens caused by the humidifiers in terms of higher need for materials, energy, and water. Potential environmental benefits increase as the efficiency of the technology in reducing losses increases. The best environmental performance was obtained when supply chains had relatively high inherent losses (more than 24%), whereas differences in transport distances, location of food production and losses disposal were not found to be important factors. Overall, proper operation of humidification technology during post-harvest is recommended to reduce environmental impacts from food supply chains.

Fabbri S., Olsen S. I., Owsianiak M., (2018). Improving environmental performance of post-harvest supply chains of fruits and vegetables in Europe: Potential contribution from ultrasonic humidification. *J. Clean. Prod.* (Under Revision).

Stoessel F., Juraske R., Pfister S., Hellweg S., 2012. Life cycle inventory and carbon and water footprint of fruits and vegetables: application to a Swiss retailer. *Environ. Sci. Technol.* 46, 3253–3262.

PROVIDE a project aiming at protein valorization through informatics, hydrolysis, and separation.

Egon Bech Hansen^{1*}, Charlotte Jacobsen¹, Ole Lund², Paolo Marcatili², Pedro J. García Moreno¹

1: DTU Food

2: DTU Bioinformatics

*Corresponding author: egbh@food.dtu.dk

The project PROVIDE aims to develop technology for the identification and production of functional peptides embedded within larger proteins. The focus is on peptide-based food and feed ingredients.

The main objectives are:

- To develop bioinformatics tools to predict functional peptides embedded in larger proteins
- To develop peptide-based food and feed ingredients from seaweed, potato or single cell protein
- Targeted activities are:
 - antimicrobials
 - antioxidants
 - gelation
 - emulsifiers
 - flavors

PROVIDE is an applied research and development project which will create value in the participating companies through the development of new products and in the food and feed industry at large by providing food and feed ingredients matching unmet needs.

The result of our research will be a technology to develop ingredients meeting demands for natural and sustainable solutions to important challenges such as:

- Increasing food safety
- Increasing shelf life and reducing food waste
- Food texture and flavors based solely on protein ingredients
- Reducing the use of “chemical additives” in food by providing protein based alternatives

The bioinformatics tools developed will pave the way for a dramatic future efficiency gain in the industry due to rapid and effective in silico detection of active ingredients of interest for the industry and an ensuing significant drop in time-to-market for new food and feed ingredient products.

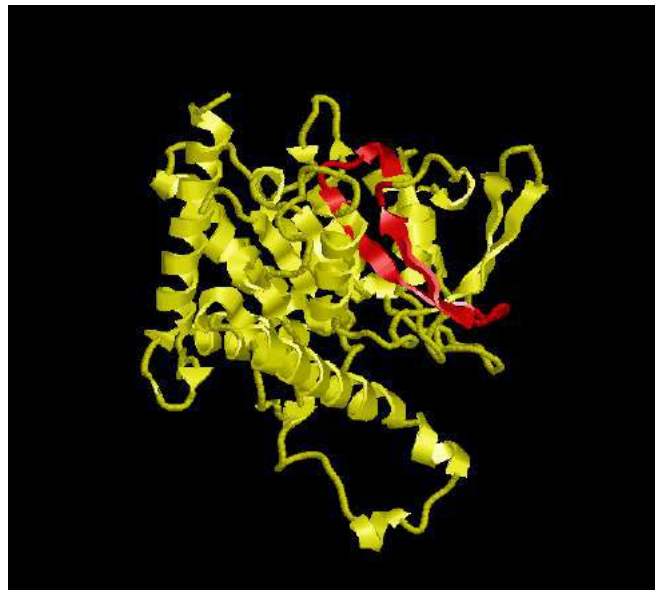



Sustainable dairy production in a life cycle perspective

Name:	Jan Dalsgaard Johannesen
Title:	Sustainability Director
Company/institution:	Arla Foods
Address:	Sønderhøj 14, 8260 Viby J
Phone:	+45 8733 2830
E-mail:	jdj@arlafoods.com

Abstract

There is an increasing pressure on our planet to deliver food to a growing population. The demand for dairy products are expected to double in 2050 compared to the beginning of the century, and it is thereby more important than ever that production is done sustainably. In the Global Dairy Agenda of Action (GDAA), signed in 2009, the dairy industry committed to reduce greenhouse gas emissions and strive to a more sustainable production. As an outcome of this commitment, the Dairy Sustainability Framework (DSF) has been developed to enable the GDAA to take a holistic approach to sustainability, focusing on eleven key areas covering the entire value chain: greenhouse gas emissions, soil nutrients, waste, water, soil, biodiversity, market development, rural economies, working conditions, product safety & quality and animal care. This allows the dairy sector to generate a common sustainability commitment that can be expressed at a global level, but also regional, national and organizational levels.

Arla Foods is a member of the DSF and have a high focus on sustainability. In a new study Arla Foods has, as one of the first food companies, assessed the total environmental footprint from the entire value chain and translated it into monetary terms, using the method Environmental Profit and Loss (also referred to as Natural Capital Accounting). The results show the total environmental impact from Arla Foods production, from cow to consumer. It also demonstrates which environmental impact categories are most significant and where in the value chain the highest impacts are. Thus, the method can be a valuable tool that can give strategic indications of how to prioritize efforts going forward.

Session

F

Laptop Presentations

See session details and schedule on
www.sustain.dtu.dk



Detection of melamine in milk using nanopillar filters and Raman spectroscopy

Onur Durucan*¹, Tomas Rindzevicius¹, Michael Stenbæk Schmidt¹, Marco Matteucci¹, Anja Boisen¹

¹: Department of Micro- and Nanotechnology, Technical University of Denmark, Kongens Lyngby, DK-2800, Denmark

*onurd@nanotech.dtu.dk

We present a simple, robust, and automated method for detecting trace amounts of melamine in milk using nanostructured surface enhanced Raman spectroscopy (SERS) substrates integrated in centrifugal microfluidic platform [1]. Fast and facile extraction of the food adulterant (melamine) from milk on a SERS substrate was demonstrated down to 10 ppm within 10 minutes. The unique characteristic of the detection method is a “filter paper/chromatographic” effect which combines centrifugal forces and wetting properties of the SERS substrate to remove lipids and larger particles and leave a purified area for melamine detection. The work addresses issues related to SERS-based detection of analytes in complex media, which is important for realizing next generation SERS platforms applicable for a fast and affordable while at the same time sensitive sensors within food safety.

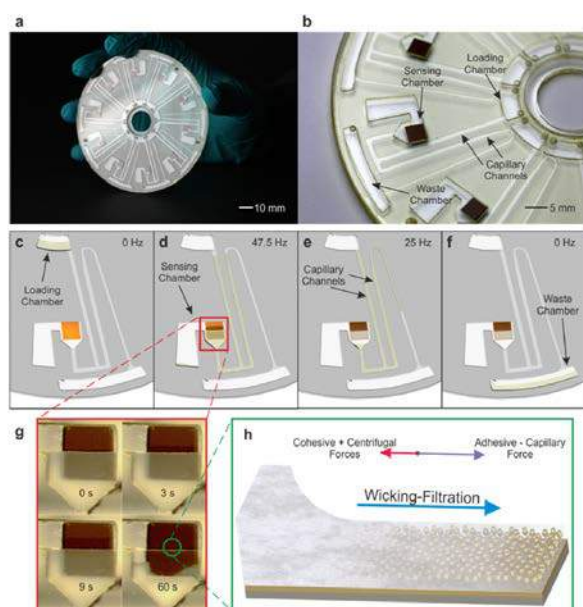

Figure 1. (a,b) Photographs of fabricated microfluidic disc. (c,d,e,f) Schematic illustration of the three-step filtration procedure: (c) the sample is injected, the disc is at rest; (d) the rotation frequency of the disc is 47.5 Hz, the sample under the action of centrifugal force is transferred to the sensing chamber and partially covered the SERS substrate; (e,f) the sample removal process with the help of pneumatic chamber and capillary channels under 25 Hz rotational frequency. (g) Real-time image series recorded during the filtration stage (d), the wet area is gradually increased and covered the whole chip in 60 s through the capillary wicking effect. (h) Illustrative drawing of capillary based wicking-filtration phenomenon on AuNP structures at the immersion boundary. [1]

[1] O. Durucan, T. Rindzevicius, M. S. Schmidt, M. Matteucci, A. Boisen, *Nanopillar Filters for Surface-Enhanced Raman Spectroscopy*, ACS Sensors, 2, 10, 1400-1404, 2017

Session

F

Poster Presentations

See session details and schedule on
www.sustain.dtu.dk





Seaweeds as a new food resource from Greenland

Katharina Johanna Kreissig *¹, Lisbeth Truelstrup Hansen¹,

¹: DTU National Food Institute

*Corresponding author email: kjkr@food.dtu.dk

Climate change is both a challenge and an opportunity for Greenland, creating the possibility of exploiting new resources such as seaweeds. Seaweeds are currently gaining a lot of attention as new food items in Denmark and Europe in general. Traditionally, consumption of seaweeds has been limited in Greenland; however, there is current interest in this food item. Greenland has an extensive coastline with clean waters that harbour a wealth of different seaweed species.

The overall objective of this PhD project is to deliver knowledge about key characteristics of Greenland seaweeds as food and to characterise areas that are suitable for future and sustainable utilisation of Greenland seaweeds.

Insect value chain in a circular bioeconomy (inVALUABLE)

J. Eilenberg¹, L.H. Heckmann², N. Gianotten³, P. Hannemann⁴, A.N. Jensen^{*5}, J.V. Norgaard⁶, N. Roos¹ and L.Bjerrum².

1: University of Copenhagen, Plant and Environmental Sciences, Frb. C, Denmark; 2: Technological Institute, Life Science, Aarhus, Denmark; 3: Proti-Farm, R&D, Ermelo, the Netherlands; 4: Hannemann Engineering, Sønderborg, Denmark; 5: Technical University of Denmark, National Food Institute, Anker Engelundsvej 1, 2800 Kgs. Lyngby, Denmark; 6: Aarhus University, Department of Animal Science, Tjele, Denmark.

*Corresponding author email: anyj@food.dtu.dk

inVALUABLE is a major collaboration project involving (mainly Danish) research institutions and companies and was initiated 2017. The project aims to contribute to improvement and development of major focus areas in the insect value chain; insect production and processing, and product application. The project will focus on optimizing reproduction, growth and health of two beetle species, namely lesser mealworm (*Alphitobius diasperinus*) and common mealworm (*Tenebrio molitor*). There will be specific focus on the future rearing facilities and automation of these in order to ensure a competitive end-product. The processing of the biomass will be investigated to find the most viable solution regarding nutritional quality for animal feed and human consumption, including optimization of protein digestibility. Animal feeding trials will be performed and the composition and ingredients in insect products will be evaluated in relation to human consumption. There will be major focus on feed and food safety and different challenges will be addressed to support related legislation. inVALUABLE will touch upon most of the insect-supply chain and produce a range of new data for use in development of insects as future feed and food. inVALUABLE is supported by Innovation Fund Denmark and has a total budget of approx. 3.7 Million EUR.



Value utilization of discarded fish livers for production of omega-3 rich oil

Ann-Dorit Moltke Sørensen^{1*}, Nina Skall Nielsen¹, Charlotte Jacobsen¹

1: Technical University of Denmark, National Food Institute, Kgs. Lyngby, Denmark

*Corresponding author email: adms@food.dtu.dk

The intake of long chain (LC) omega-3 polyunsaturated fatty acids (PUFAs), especially eicosapentaenoic acid (EPA) and docosahexaenoic acid (DHA), has been associated with several health beneficial effects. Thus, there is a demand for new methods to obtain high quality omega-3 rich oils and applications with omega-3 to increase the population's intake of the healthy omega-3 LC PUFAs.

Most of the fish caught in Denmark are slaughtered and rinsed immediately after catch, when the fishing vessel is still at the sea. When the fish is rinsed, the liver is discarded in to the sea. However, this practice has now been prohibited in the new EU legislation. Liver from fish has a high content of omega-3 LC PUFAs, i.e. EPA and DHA. This liver could be stored and used for production of oil rich in omega-3 and thus, create value from waste material.

The quality of the livers will affect the quality of the oil produced. Thus, a good quality of the waste material has to be preserved from catch to oil production. Parameters that can affect the quality of the liver from catch to oil production are storage condition and initial oxidation status. The aim of this study was to evaluate the effect of storage conditions (iced and -18 °C) on board the fishing vessel on the oxidative quality of the livers obtained from different cod species. Additionally, a systematic evaluation of seasonal variation in oil content, oxidation status and fatty acid composition was performed on different cod species.

Session

G

Oral Presentations

See session details and schedule on
www.sustain.dtu.dk



DripView: a smart water sensor to take control of your water use

Andreas Vejbæk Mønster¹, Peter Nørtoft^{*1}, Josefine Lange Strandgaard¹

1: Aqubiq ApS, Diplomvej 381, 2800 Kgs. Lyngby, Denmark.

*Corresponding author email: peter.nortoft@aqubiq.com.

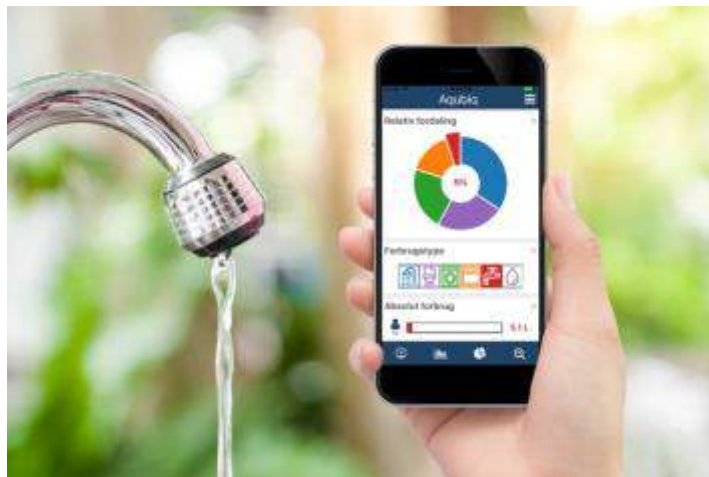

Figure 1: By analyzing consumption patterns, DripView can estimate how much water the appliances in the home use: shower, washing machine, toilet etc.

Clean water is something we take for granted in Denmark: we open the tap, and out comes the water. But few of us are aware of how much water we actually use. And even fewer know what exactly the water is used for. We believe this lack of knowledge creates a waste of water. This paradox becomes even more pronounced in places like Singapore and California, where water is scarce, but data often abundant.

This is the main motivation behind DripView. DripView is a smart water sensor designed to help people save water at home. Through increased awareness and more qualified information, our goal in Aqubiq is to help save 15% water. The system consists of three elements: a high-resolution sensor device that mounts on top of a water meter, a cloud-part that stores and analyzes the water consumption data, and a smartphone app to give a deeper and more inspiring insight into the water use.

Aqubiq is a young green tech startup from DTU. Over the past year, we have developed the product together with innovative clients and supportive partners, including DTU Campus Service, Roskilde Festival, Faxe Forsyning A/S, and DR. In this talk, we give a short demonstration of our product, elaborate on some of the ups and downs along our journey as a green tech startup in Denmark, and explain how a so-called WISE project with DTU Environment and DTU Compute helped us in the innovative process.



Cloud Service for Strategic Management of Inflow and Infiltration in Sewer Networks.

Morten Grum¹

1: WaterZerv

*mortengrum@waterzerv.com

Sustainable delivery of urban wastewater services is challenged by urbanization, climate change and aging infrastructure causing increased pollution of surface waters, laps in the delivered service level and depletion of groundwater resources. Inflow and infiltration through misconnections and deteriorating networks plays a major role in the environmental and functional performance of wastewater systems. Strategic management of inflow and infiltration represents an often-underexploited potential in securing sustainable delivery of wastewater services within the constraints of public utility budgets.

WaterZerv has developed a cloud service that allows for improved investment planning based on an improved knowledge about inflow and infiltration in the network. A continuous overview of inflow and infiltration is provided in a cloud service that receives and analyses data from rain gauges, pumping stations and flow meters in the network.

WaterZerv is a knowledge based start-up providing web services and the described data analysis service, *InflowGo*, is developed in corporation with both wastewater utilities and universities. At WaterZerv we believe that only a fraction of scientific, mathematical and engineering research within the field of urban water management is exploited to its full potential. Our ambition is to mobilize these large pools of knowledge to create real value in the world of urban water. *InflowGo* is our first service and more will follow.

Fragrant plants used as air fresheners in private households

Henrik Toft Simonsen *1

1 DTU Bioengineering, Technical University of Denmark and Mosspiration Biotech IVS
Corresponding author email: hets@dtu.dk

Direct assembly of multiple linear DNA fragments via homologous recombination, a phenomenon known as *in vivo* assembly was recently introduced as a technology for transformation of the moss *Physcomitrella patens*¹. This technology has enable us to establish several sesquiterpenoid-producing lines in this green cell factory². We have demonstrated that we in moss can produce up to 200 mg/L amorphadiene (the precursor for Artemisinin) and that we can achieve a production of 0.21 mg/g dry weight of Artemisinin within just a few days of cultivation³.

Similarly we have established lines that produce several fragrances of patchoulol⁴, santalene⁴, bisabolol, α -humulene and valencene at the levels between 0.2 – 1.8 mg/g dry weight. Altogether, this show that the moss is a very good cell factory for the production of terpenoids and in particularly sesquiterpenoids. This has allowed us to establish a fragrant moss line, see more www.orbellamoss.com

Our research also demonstrates that employing the same strategies as for yeast, such as upregulation of HMGR and overexpression of FPPS enhances the overall yield of terpenoids⁴.

These proof-of-principle experiments have paved the way for more complex and increasingly flexible approaches for large-scale metabolic engineering in plant biotechnology. First was the successful integration of five active genes for Artemisinin, but the focus is now for truly freshening fragrances for private households.

1. King, B.C., *et al.*, Sci Rep, 2016. **6**:25030
2. Ikram, N.K.B.K., *et al.*, Front Plant Sci, 2015. **6**:129
3. Khairul Ikram, N.K.B., *et al.*, Front Bioeng Biotech, 2017. **5**:47
4. Zhan, X., *et al.*, Front Plant Sci, 2014. **5**:636



Rest to Resource – Circular Innovation and Business Development in SMEs

Maj Munch Andersen^{*1}, Alessandro Seti², Daniela Pigosso³

1: Department of Management, TIM, DTU, mmua@dtu.dk

2: Department of Management, TIM, DTU

3: DTU MEK

The EU Regional fund project Rest to Resource runs from 2016-2018. The project investigates and seek to promote green and circular business development in Danish SMEs. Project leader is Danish Symbiosis Center with DTU as the main analytical partner.

A special feature of the project is that it works through and with six municipalities in region Vestsjælland, analyzing and promoting the municipalities' capacity to facilitate circular innovation in 100 SMEs.

In the preparation phase we developed a circular company screening tool, we educated the municipalities in green business development, we set out procedures for identifying potential companies and worked with the company-municipal interface.

Another core feature is that we in the circular screening tool and succeeding green business model workshops highlight both business model aspects and environmental aspects. In considering CE potentials we include both materials, water and energy and the trade off between resource efficiency, internal recycling and symbiotic recycling, see figure below.

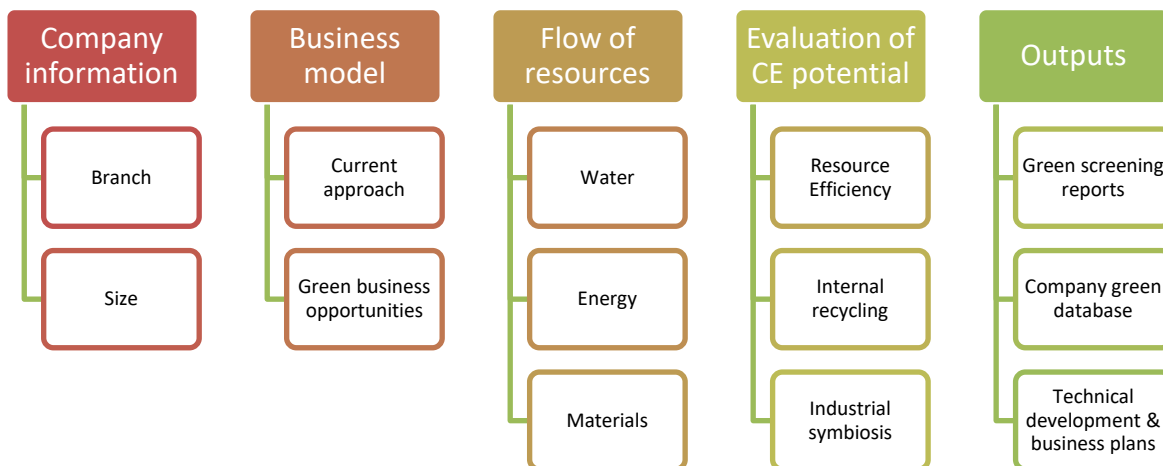

Core outputs are company green screening reports, a company green database and for the companies green technical and business plans developed in collaboration with consultants, a few together with DTU students. The green industrial dynamics of the SMEs are being further analyzed based on the data provided feeding into eco-innovation and green and circular economy research. The project is ongoing and papers have still not been published.

Access to electricity in rural Africa - from donor support to innovative business models

Ivan Nygaard ^{* 1)}, Ulrich Elmer Hansen ¹⁾, Thomas Hebo Larsen ¹⁾

¹⁾ UNEP DTU Partnership, DTU Management Engineering, DTU

^{**} Corresponding author email: ivny@dtu.dk

The traditional model of rural electrification in Sub-Saharan Africa (SSA) mainly involves donor and government-supported programs. Recently, however, a rapid and significant increase has occurred in the sale of pico-scale solar products throughout SSA. This development is driven by an increasing number of private firms supplying pico-scale solar systems to customers, on a commercial basis, in order to serve their electricity and lighting needs. The system suppliers take advantage of the substantial improvement in the price and efficiency of core technology components, the emergence of smart metering technologies, and the wide spread use of mobile phones and mobile payment schemes. Suppliers are, thus, able to target poor customers located mainly in off-grid, rural areas through new pay-as-you-go business models that avoid high upfront costs. With the parallel rise in the costs of conventional sources of electricity and lighting, especially diesel and kerosene, the demand for pico-scale solar appliances has boomed. These factors are driving a remarkable and unprecedented diffusion of pico-scale solar PV products on market terms, which stands in contrast to the donor and government-driven model of rural electrification

References

- Alstone, P., Gershenson, D., Turman-Bryant, N., Kammen, D.M., Jacobson, A., 2015. Off - Grid Power and Connectivity - Pay -As - You-Go financing and digital supply chains for pico-solar. University of California, Berkeley and Lighting Global.
- Diecker, J., Wheeldon, S., Scott, A., 2016. Accelerating access to electricity in Africa with off-grid solar: Policies to expand the market for solar household solutions. Overseas Development Institute.
- Hansen, U.E., Pedersen, M.B., Nygaard, I., 2015. Review of Solar PV market development in East Africa. *Renew. Sustain. Energy Rev.* 46, 236–248. doi:10.1016/j.rser.2015.02.046
- Lee, K., Brewer, E., Christiano, C., Meyo, F., Miguel, E., Podolsky, M., Rosa, J., Wolfram, C., 2016. Electrification for “under Grid” households in Rural Kenya. *Dev. Eng.* 1, 26–35. doi:10.1016/j.deveng.2015.12.001
- MoEP, 2016. Current activities and challenges to scaling up mini-grids in kenya. Ministry of Energy and Petroleum, Kenya and ESMAP, World Bank
- Nygaard, I., 2009. Compatibility of rural electrification and promotion of low-carbon technologies in development countries: The case of Solar PV for Sub-Saharan Africa. *Eur. Rev. Energy Mark.* 3, 125–158.
- Orlandi, I., Tyabji, N., Chase, J., 2016. Off-grid solar market trends report 2016. Bloomberg New Energy Finance, World Bank, IFC and Global Off-grid Lighting Association. doi:10.1017/CBO9781107415324.004
- Pedersen, MB, 2017, Rural electrification through private models: the case of solar-powered mini-grid development in Kenya: Exploring the hybrid nature of private business models and the interplay between new players and existing structures in the Kenyan rural electrification regime. Ph.D. thesis. UNEP DTU Partnership
- Rolffs, P., Ockwell, D., Byrne, R., 2015. Beyond technology and finance: pay-as-you-go sustainable energy access and theories of social change. *Environ. Plan. A* 47, 2609–2627. doi:10.1177/0308518X15615368
- Scott, A., Miller, C., 2016. Accelerating access to electricity in Africa with off - grid solar: The market for solar household solutions. Overseas Development Institute.

Session

G

Poster Presentations

See session details and schedule on
www.sustain.dtu.dk



A Guide for Evaluating the Environmental Performance of Product/Service-Systems

Louise Laumann Kjaer*¹, Daniela C. A. Pigosso¹, Tim C. McAlloone¹

1: DTU; Department of Mechanical Engineering; Engineering Design & Product Development

*Corresponding author email: llkj@dtu.dk

New business opportunities and improved sustainability can be fostered by delivering product functionality rather than ownership through e.g. sharing systems, performance-based contracts, subscriptions etc. (Bocken et al., 2014). This is aligned with the concept of Product/Service-Systems (PSS), in which products and services are combined in a system to satisfy user needs (Baines et al., 2007). However, it is well known that PSS offerings are not necessarily more sustainable from an environmental perspective. Because of that, systematic and quantitative assessments of their actual environmental performance are called for (Kjaer et al., 2016). In order to address this issue, a Guide for evaluating the environmental performance of PSS based on Life Cycle Assessment (LCA) methodology has been proposed. The Guide was developed based on identified challenges for LCA on PSS, a review of existing LCA on PSS case studies, expert consultations, case study applications, and structured user feedback. The guide consists of 6 steps (Figure 1), which are aligned with the phases of an LCA. The guide focus on defining a proper study scoping to ensure (i) that the reference system to which the PSS is compared is properly explored and that relevant product systems that the PSS substitutes are identified (supported by step 2), (ii) that the system chosen for analysis are comparable in terms of functional outcome and perceived value, since differences in user perceived outcome might trigger rebound effects (supported by step 3), and (iii) that all relevant processes on which the PSS depends are included in the assessment (supported by step 3). The Guide may be used by industry, authorities or researchers interested in evaluating the environmental performance of PSS. Future work includes various full case applications and further enhancement of the Guide through collaborations with relevant stakeholders.

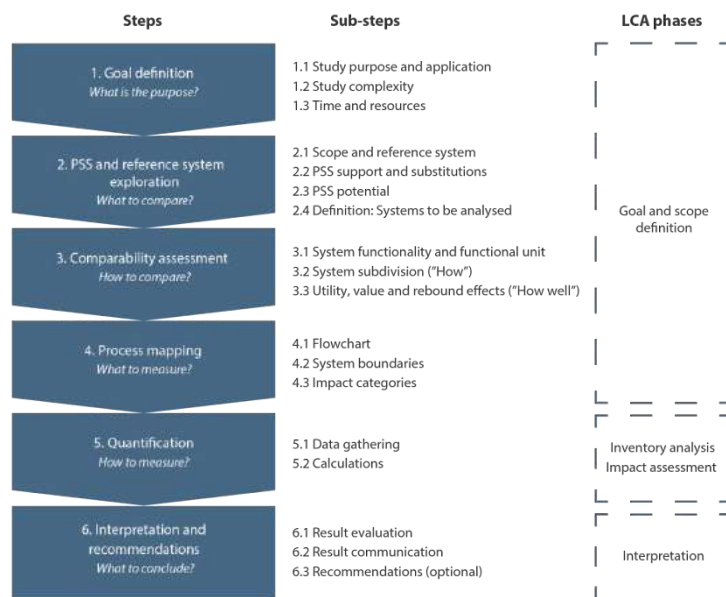

Figure 1: Overview of guide steps

Baines, T.S., Lightfoot, H.W., Evans, S., Neely, A., Greenough, R., Peppard, J., Roy, R., Shehab, E., Braganza, A., Tiwari, A., Alcock, J.R., Angus, J.P., Bastl, M., Cousens, A., Irving, P., Johnson, M., Kingston, J., Lockett, H., Martinez, V., Michele, P., Tranfield, D., Walton, I.M., Wilson, H., 2007. State-of-the-art in product-service systems. Proc. Inst. Mech. Eng. Part B J. Eng. Manuf. 221, 1543–1552.

Bocken, N.M.P., Short, S.W., Rana, P., Evans, S., 2014. A literature and practice review to develop sustainable business model archetypes. J. Clean. Prod. 65, 42–56.

Kjaer, L.L., Pagoropoulos, A., Schmidt, J.H., McAlloone, T.C., 2016. Challenges when evaluating Product/Service-Systems through Life Cycle Assessment. J. Clean. Prod. 120, 95–104.



Scientific support for business with implementing circular economy for enhanced competitiveness and sustainability

Tim McAlloone¹, Daniela Pigosso¹, Fenna Blomsma*¹, Marina Pieroni¹, Mariia Kravchenko¹

¹ Technical University of Denmark

* fblo@dtu.dk

Circular economy is a promising approach towards maximising value by increasing resource productivity, enhancing energy efficiency, lowering resource consumption and decreasing waste. The idea central to circular economy is to move away from linear practices and “take-make-use-dispose” approaches. Instead, industrial systems should continue to extract value from resources by extending their productive lifetimes. This can be achieved through material ‘cycling’, thinking of recycling, cascading and industrial symbiosis, or product ‘cycling’ by applying such tactics as reuse, repair, upgrading, remanufacturing, redistribution and product/service-systems.

The CIRCit research project will develop science-based tools and approaches with the aim of supporting the Nordic industry in its transition to a circular economy in six main areas:

- Business model innovation - including new offerings and value propositions
- Circular product design - for enhanced value creation
- Intelligent product operations - through the Internet of Things (IoT) and big data
- Closed loop strategies - based on product design and end-of-life/ use treatment possibilities
- Development of cross-sectoral collaborations and networking initiatives
- Sustainability evaluation - based on economic, environmental and social indicators

This poster will explain about CIRCit’s approach to circular economy, the action research oriented approach through working with businesses and the integrated manner in which the tool-kit is being developed.

CIRCit is a collaboration between the Technical University of Denmark (DTU), the Norwegian University of Science and Technology (NTNU), Technology Industries of Finland, SWEREA and the Innovation Center Iceland. CIRCit is supported by the Nordic Green Growth Initiative, a joint programme supported by NordForsk, Nordic Energy Research and Nordic Innovation.

Making the Transition to Circular Economy through readiness assessment

Tim C. McAlloone, Daniela C. A. Pigosso, Lærke Spaabæk Perrild*



*Corresponding author email: lscho@mek.dtu.dk

Circular Economy (CE) is an emerging industry paradigm where the focus is on ensuring better management of resources while enabling new business opportunities through new business models. When investigating best practices by Danish manufacturing companies operating CE we see examples of thriving circular pioneer cases, but still a limited number, indicating critical barriers for a complete transition.

MATCHe is an innovation programme carried out by DTU in order to support Danish industry to increase its competitiveness, growth and job creation by demonstrating how to engage in an effective transition towards CE, based on current readiness assessment and strategic driver identification. By enabling an effective transition of Danish industry towards CE, a long-term systemic and sustainable enhancement of the Danish economy and society is expected, with value maximization and increased resource productivity.

MATCHe enables manufacturing companies to understand their readiness towards CE and plan their transition paths going from a linear to a circular economy. MATCHe brings along knowledge, best practices, and support around four overall transition steps. Step 1 is an online universe, which brings curated knowledge based on a continuous consolidation of CE tools, cases and relevant reports that can help companies planning and further advancing their transition. Creating a circular model requires fundamental changes throughout the value chain, from innovation, product design and production processes all the way to end of life, new business models and consumption patterns. Knowing your current readiness status is key to start this transition! This leads to step 2, which is a digital Readiness Assessment for Circular Economy, developed by MATCHe. The assessment helps companies to understand their readiness along eight key dimensions. A Readiness Profile, as well as Internal and External Benchmarking are results generated from the assessment, supporting companies to know what their status is and get an overview of strategic possibilities. Having reached a state of circular self-awareness, the companies are ready to implement CE initiatives. This is the focus for step 3. MATCHe offers companies a tailor-made accelerator programme with the purpose of supporting and advancing implementation of an effective transition, bringing up best practices for long-lasting change. Finally, step 4 explores how value chain and cross-sectorial collaboration can lead to scalable impact. MATCHe brings companies together to exchange best practices on transition routes to find solutions for similar challenges and to explore shared opportunities.

The project's primary audience is the Danish manufacturing industry, including their upstream and downstream value chains, across numerous sectors. Industry companies include significant players in the Danish economy, embracing large manufacturing companies and Small and Medium-sized Enterprises (SMEs). This broad perspective will generate valuable data, which are transferred into open-source guides on transition routes, starting with the readiness assessment, across the Danish industry landscape.

The integration of Sustainable Development Goals into sustainability reports

Lourenço G. D. Faria¹, Francesco Rosati^{1*}

¹: DTU Management Engineering, Technology and Innovation Management Division

*Corresponding author email: frro@dtu.dk

A great challenge towards the implementation of a green economy is how to change business attitudes towards sustainable practices, technologies and business models (Schaltegger, Lüdeke-Freund, & Hansen, 2012). Most of the literature on organization behavior and sustainable development focus on the effects of regulatory compliance, stakeholder pressure and competitive pressure when investigating the sources of adoption of sustainable practices and technologies (Calabrese et al., 2013; Elliot, 2013), while the influence of internal characteristics and past behavior of the organizations is considered a black box (Faria and Andersen, 2017). We argue that there is a gap on the literature concerning organization structural characteristics and attitudes, which might influence the decision of such organizations to report (or not) sustainable practices and guidelines.

In this sense, the aim of this paper is to understand the relationship between organizations' structural factors and their reporting on the Sustainable Development Goals (SDGs) which were presented during the General Assembly of United Nations, as part of the 2030 Agenda for Sustainable Development (United Nations General Assembly, 2015). We present descriptive data and evaluate statistically the existence of patterns within the characteristics of a sample of 400+ organizations that mention, or do not mention, the SDGs in their respective sustainability reports in the fiscal year of 2016. We use the influence of top management characteristics (e.g. age, gender), organization size, economic performance, and degree of intangibility (as proxy for unique technological and organizational competences) as predictors in the model.

References

- Calabrese, A., Costa, R., Menichini, T., Rosati, F., & Sanfelice, G. (2013). Turning Corporate Social Responsibility- driven Opportunities in Competitive Advantages : a Two-dimensional Model. *Knowledge and Process Management*, 20(1), pp. 50-58.
- Elliot, S., 2013. A transdisciplinary exploratory model of corporate responses to the challenges of environmental sustainability. *Business strategy and the environment*, 22(4), pp.269-282.
- Faria, L.G.D. and Andersen, M.M., 2017. Sectoral patterns versus firm-level heterogeneity-The dynamics of eco-innovation strategies in the automotive sector. *Technological Forecasting and Social Change*, 117, pp.266-281.
- Lovins, A.B., Lovins, L.H. and Hawken, P., 1999. A road map for natural capitalism. *Harvard business review*, 77, pp.145-161.
- Schaltegger, S., Lüdeke-Freund, F., & Hansen, E. G. (2012). Business cases for sustainability: the role of business model innovation for corporate sustainability. *International Journal of Innovation and Sustainable Development*, 6(2), pp. 95-119.
- United Nations General Assembly. (2015). *Transforming our world: The 2030 agenda for sustainable development*. New York.

Session

H

Oral Presentations

See session details and schedule on
www.sustain.dtu.dk



Biomechanical study of porcine urinary bladder wall: matter of isotropy or anisotropy

Fatemeh Ajallouei^{1*}, Maryam Sami Jokandan², Ioannis S Chronakis³

1: Research Group for Nano-Bio Science, Technical University of Denmark, Kemitorvet, 2800 Kgs. Lyngby, Denmark

*Corresponding author email: faaj@food.dtu.dk

Regenerative medicine for reconstructive urogenital surgery has been widely studied during the last two decades[1]. One of the key factors affecting the quality of bladder regeneration is the mechanical properties of the bladder scaffold. Due to extensive similarity of porcine bladder to human bladder[2], and availability of this tissue from local slaughterhouses, we applied porcine bladder. The outcomes from this study can assist researchers with better solutions for design of scaffolds for bladder tissue engineering aiming to provide patients with high quality life in the future.

In most studies, test samples were preserved at -20°C prior to testing. However, we applied fresh samples in all our experiments, as the effect of storage temperature on bladder's mechanical properties is not systematically investigated yet[3]. Bladder is understood to have anisotropic mechanical properties. In order to properly study the anisotropic properties of bladder wall, uniaxial tests were applied under loading conditions similar to physiologic filling of bladder (1–2 mL/min) to evaluate how circumferential and longitudinal cut-outs of lateral region of bladder behave under load. Uniaxial tensile tests under low strain rate of 10 mm/min (0.4%/s) were applied onto rectangular shaped samples. The different strain amplitudes for uniaxial tests are 2.5, 5, 10, 20, 50, 100, 200 and 300%. Samples were under cyclic loading-unloading for 11 rounds, and the data from 11th cycle were applied for further analysis. The first 10 cycles were considered for preconditioning.

Our results demonstrate that bladder behaves isotropic at strain amplitudes below 200%, while at strains above 200% becomes slightly stiffer in longitudinal direction. We conclude that commenting upon isotropy/anisotropy of bladder wall needs to be subjective. It behaves isotropic under physiologic conditions and low strain loads, but anisotropic under high strain amplitudes. We sum up that it is important to consider the study parameters, when referring to mechanical data from reports in literature.

References:

- [1] F. Ajallouei, S. Zeiai, M. Fossum, J.G. Hilborn, *Biomaterials*. 35 (2014) 5741–8.
- [2] S. Korossis, F. Bolland, J. Southgate, E. Ingham, J. Fisher, *Biomaterials*. 30 (2009) 266–275.
- [3] A.N. Natali, A.L. Audenino, W. Artibani, C.G. Fontanella, E.L. Carniel, E.M. Zanetti, *J. Biomech*. 48 (2015) 3088–3096.

Dispersive Molecular Imprinting of Proteins for the Production of Plastic Antibodies

Jon Ashley, Xiaotong Feng, Arnab Halder, Tongchang Zhou and Yi Sun*

Department of Micro and Nanotechnology, Technical University of Denmark
Ørstedss Plads, DK- 2800 Kgs, Lyngby, Denmark.

*Corresponding author email: Sun.Yi@nanotech.dtu.dk

The increased use of natural antibodies as affinity agents in both basic and applied research for the detection of proteins has resulted in a higher demand for the use of animals needed to raise these antibodies. As a result there is a push to reduce the dependency on animals in research through the development of synthetic alternatives. One area of increasing promise is in the development of nano based molecularly imprinted polymers (nanoMIPs) better known as plastic antibodies^[1]. These artificial receptors are formed by crosslinking functional monomers in the presence of a protein template to form nano sized polymers. After the removal of the template, a binding recognition site selective for the protein is left behind. Some challenges still remain to imprinting proteins such as difficulties in template removal, low yields and retention of the native structure of the protein during polymerization.

With this in mind, we set out to develop a new imprinting methodology which overcomes some of the limitations associated with conventional imprinting methods^[2]. The new approach termed “dispersive solid-phase imprinting” where the template protein is immobilized onto the surface of magnetic microspheres as a solid-phase which allows for the plastic antibody to be imprinted round the protein. This methodology demonstrates some attractive advantages over other solid-phase materials. The high surface to volume ratio of magnetic microspheres leads to increased rates of immobilization of protein and increased yields of plastic antibody per g of solid phase used. Unlike glass beads, magnetic microspheres do not suffer from abrasion due to their molecular sizes (600 - 700 nm) which allows for reaction mixtures to be dispersed throughout the mixture during the polymerization and in turn leads to increased solution-phase reaction volumes. The use of a magnetic core allows for the easy manipulation of the microspheres during the washing and elution steps with both reaction and purification steps being completed within 3 hours (**Scheme 1**). Using trypsin as a model protein, we developed plastic antibodies which were synthesized and characterized using TEM and dynamic light scattering demonstrating a size of about 209 nm. The plastic antibodies demonstrated a high binding affinity (2×10^{-7} M) and selectivity towards trypsin. Overall plastic antibodies could potentially replace the use natural antibodies in healthcare based applications, increase the shelf life of antibody based bioassays and medical diagnostic kits as well as reduce the use of animals in biological research.

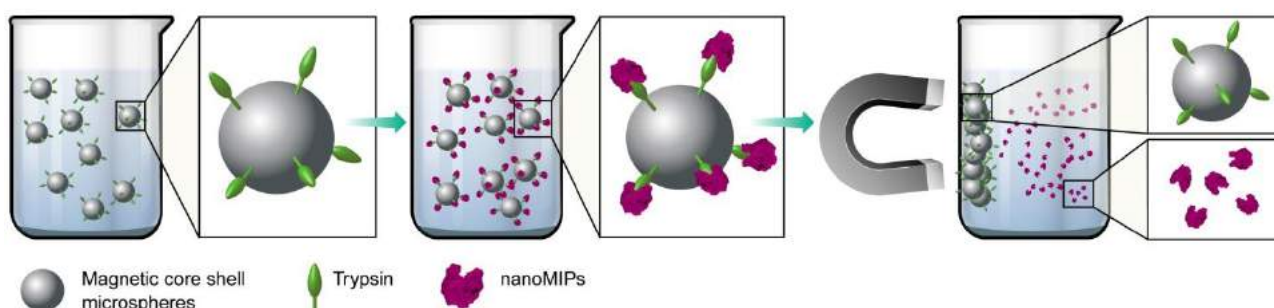

Scheme 1: Overview of dispersive molecular imprinting.

- [1] J. Ashley, M.-A. Shahbazi, K. Kant, V. A. Chidambara, A. Wolff, D. D. Bang, Y. Sun, *Biosens. Bioelectron.* **2017**, *91*, 606–615.
[2] F. Canfarotta, A. Poma, A. Guerreiro, S. Piletsky, *Nat. Protoc.* **2016**, *11*, 443–55.

CRISPR Genome Editing with Artificial Intelligence

Leigh Brody

The adoption of CRISPR in the field of gene-editing is revolutionizing biomedical research and drug discovery by providing a powerful tool for precise genome modification in a robust and highly targeted manner. It has demonstrated increased benefits over previous forms of gene editing, such as TALENs and zinc finger nucleases (ZFN), with its relative simplicity and higher efficiency at performing bi-allelic gene modifications.

One of the most critical part of a CRISPR experiment is the design of guide RNAs (gRNAs) which is a complex multi-variate problem. The weight of each variable differs depending on the experiment under consideration. Current methods of designing CRISPR experiments with the DESKGEN platform are based on artificial intelligence *in silico* prediction of gRNA efficiency and specificity.

Given the wide use of CRISPR in biomedical research and potential for clinical applications, there is an increasing need to understand both intended and genome-wide target specificities of CRISPR gene-editing experiments. In particular, the sustainability of CRISPR experiments applied to a wide range of applications and the development of artificial intelligence to drive the field forward.

Biomimetic Approaches towards the Creation of Artificial Cells and Organelles for Future Healthcare Solutions

Leticia Hosta-Rigau^{*1}, Maria Godoy-Gallardo¹, Cedric Labay¹

1: Department for Micro- and Nanotechnology, Centre for Nanomedicine and Theranostics, DTU Nanotech, Technical University of Denmark

*leri@nanotech.dtu.dk

Therapeutic cell mimicry is an approach that aims to substitute for missing or lost cellular function often in the context of a missing enzyme and, thus, is expected to be a powerful tool for enzyme replacement therapy.

The main feature of biological cells and organelles is compartmentalization. There is no life without compartmentalization and biological cells have developed this strategy as a powerful tool to optimize the chemistry and physics using a single bilayer.

We have recently reported a new class of multicompartiment carriers mimicking the compartmentalized structure of a cell which consist in thousands of liposomes embedded within a polymeric carrier capsule.

In this talk I will present examples of our multicompartiment carrier working as artificial cells towards the treatment of conditions due to a malfunctioning enzyme or as an erythrocyte mimic towards the creation of a universal red blood cell substitute.

Furthermore, when administered into cells, our multicompartiment carrier can act as a “cell implant” in the form of artificial organelles that can contribute to the treatment of several cell disorders by replenishing diminished cell activity.

Therefore, in this talk I will give an insight of how this new class of therapeutics can be used as sustainable therapies for a variety of diseases.

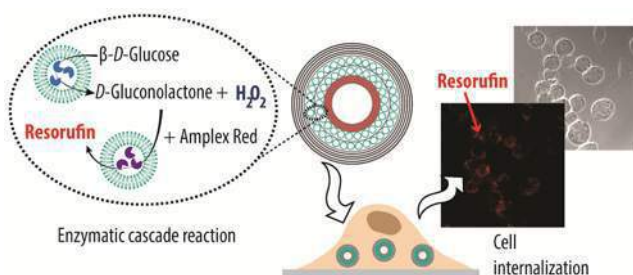

Wireless Powered Lab-on-Disc Platform for Measurements on the Spin

Jen-Hung Wang², Chung-Hsiang Cheng², Sriram Thoppe Rajendran¹, Kinga Zor¹, Wei-Min Wang², Anja Boisen¹, Kuang-Yuh Huang² and En-Te Hwu*¹

¹Technical University of Denmark, Denmark

²National Taiwan University, Taiwan

*Corresponding author email: etehw@nanotech.dtu.dk

We integrate Qi wireless power, Arduino microcontroller, Bluetooth signal transmission and lab-on-disc technique for developing a sample-to-answer biosensing platform (Fig. a). The wireless powered lab-on-disc platform (PloD) connects to an Android smartphone for real-time digital to analog converter (DAC) and analog to digital converter (ADC) control. Furthermore, the PloD is capable of measuring data while spinning, as shown in Fig. b and c.

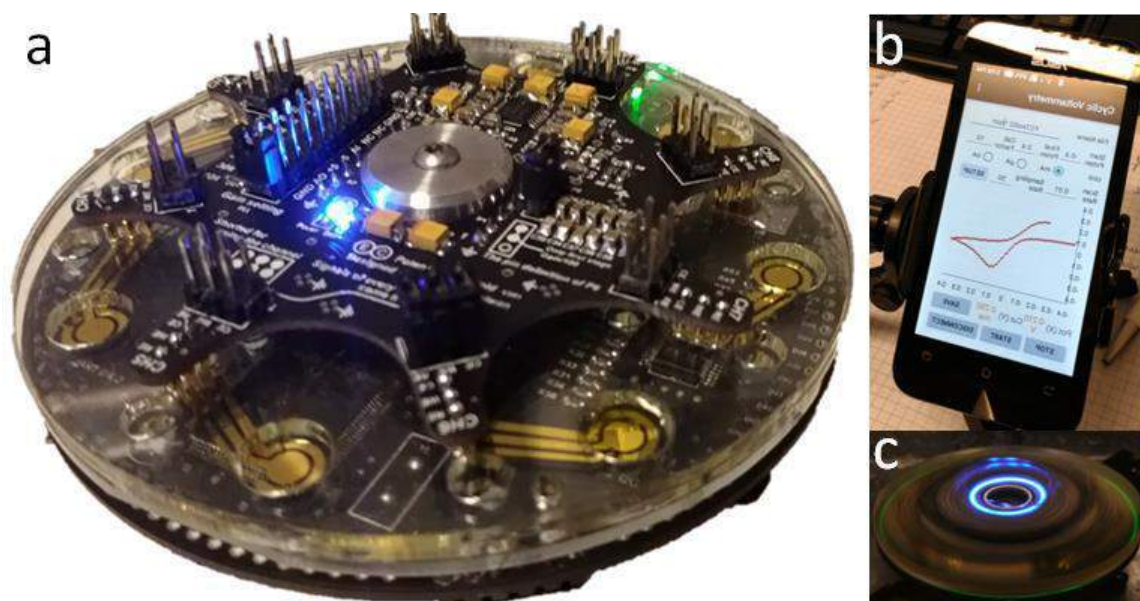

The first application of the PloD is a potentiostat for electrochemical based biosensing [1], we have successfully measure Ferri Ferrocyanides Current-Potential curve while spinning from 0 to 3000 rpm. There are various lab-on-disc applications[2] can be carry out by the PloD platform for the future stand-alone diagnostics and healthcare systems.

Reference

- [1] K. Zor, A. Heiskanen, C. Caviglia, M. Vergani, E. Landini, F. Shah, M. Carminati, A. Martinez-Serrano, T. R. Moreno, M. Kokaia, D. Benayahu, Z. Keresztes, D. Papkovsky, U. Wollenberger, W. E. Svendsen, M. Dimaki, G. Ferrari, R. Raiteri, M. Sampietro, M. Dufva, and J. Emneus, "A compact multifunctional microfluidic platform for exploring cellular dynamics in real-time using electrochemical detection", *Rsc Advances*, vol. 4 (2014), pp. 63761 - 63771.
- [2] P. Kassal, J. Kim, R. Kumar, W. R. de Araujo, I. M. Steinberg, M. D. Steinberg, and J. Wang, "Smart bandage with wireless connectivity for uric acid biosensing as an indicator of wound status", *Electrochemistry Communications*, vol. 56 (2015), pp. 6 - 10.

Deep feature learning for virus detection using a Convolutional Neural Network

Diego Calvo^{1,2}, Isabel de la Torre², Manuel Angel Franco², Søren Brunak¹, José M.G. Izarzugaza^{*1}

1: Department of Bioinformatics, Technical University of Denmark, Kgs. Lyngby, Denmark.

2: Department of Signal Theory and Communications, University of Valladolid, Valladolid, Spain.

*Corresponding author e-mail: txema@bioinformatics.dtu.dk

This study is focused on the development of a technology to identify characteristics in nucleotide sequences using deep learning provided by Convolutional Neural Networks. In order to demonstrate the effectiveness of this technology, a classifier has been developed to identify viruses in sequencing reads of 100 nucleotides, a proxy for a real NGS scenario. This classifier is able to search for known virus characteristics and identify potential new viruses that are currently undetected. As it is not necessary to read the complete sequences to recognize a virus, we manage to reduce the time and costs of virus identification.

The used Convolutional Neural Network to develop the classifier has been trained with RefSeq data. The training set was made up of two subsets. The first subset (positive set) includes all the nucleotides sequences of found viruses in the database and the second subset (negative set) is composed by a random selection of all the nucleotide sequences of non-viruses respecting the existing proportion of each found specie.

This training group undergoes is partitioning, overlapping and data cleaning transformations and it has resulted in a training set of 39.807.052 elements of approximately 2.2Gb of storage.

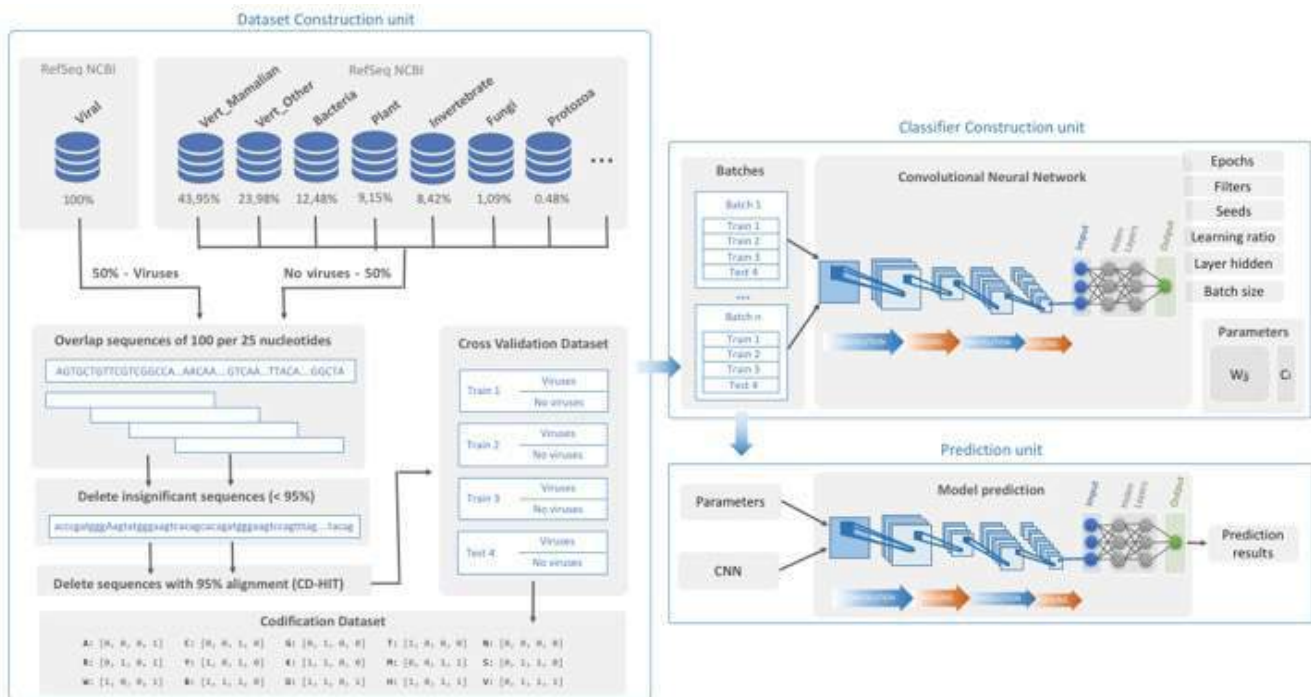

Microcontainers for Oral Vaccine Delivery

Line Hagner Nielsen^{1*}, Christoffer von Halling Laier¹, Anja Boisen¹

1: The Danish National Research Foundation and Villum Foundation's Center for Intelligent Drug Delivery and Sensing Using Microcontainers and Nanomechanics (IDUN), Department of Micro- and Nanotechnology, Technical University of Denmark, Kgs. Lyngby, Denmark

*Corresponding author email: lihan@nanotech.dtu.dk

Vaccination is considered one of the most significant contributions to public health and disease prevention and it is also believed to be a very cost-effective medical intervention [1]. Vaccination has reduced the morbidity and mortality resulting from diseases such as tuberculosis and smallpox and has thereby saved millions of lives. In spite of this, many infectious diseases remain endemic in large parts of the world, and therefore vaccination is an area in continuous development [1].

Delivery of vaccines is often done by injection, but it would be much more convenient for the patients and provide prospective for mass vaccination, if the vaccines could be dosed via the oral route. For being able to do so, a combination of an antigen, adjuvant and a particulate system is necessary. An example of such a particulate system is cubosomes. Cubosomes are highly twisted, continuous lipid bilayers with two congruent, non-intersecting water channels providing both hydrophilic and hydrophobic domains and a large surface area for associations of antigens and adjuvants [2]. Following the oral delivery of the vaccine formulation, it needs to pass through the harsh environment of the stomach with low pH value and degradation enzymes, and then reach the small intestine where absorption into the blood stream should occur. For protection of the vaccine formulation, micro fabricated drug delivery devices can be used. Of these micro devices, microcontainers are suggested as especially promising [3]. Microcontainers are polymeric, cylindrical devices in the micrometer size range (Fig. 1). A potential advantage of microcontainers is that these devices allow for unidirectional release, as only one side is open compared to conventional particles where release occurs from the whole surface [3]. Moreover, microcontainers have been observed to interact with the intestinal mucus layer resulting in prolonged and increased absorption of poorly soluble drugs compared to controls without microcontainers [3,4].

In this work, cubosomes powder carrying the model antigen ovalbumin and the adjuvant Quil-A was prepared using spray drying as production method [5]. The powder was subsequently loaded into SU-8 microcontainers. For protection of the vaccine formulation in the microcontainers, a lid of the pH-sensitive polymer Eudragit L100-55 was deposited on the cavity of the microcontainers for protection of the vaccine formulation through the stomach (Fig. 2). This vaccine-loaded microcontainer system is further tested for the potential application in oral vaccine delivery.

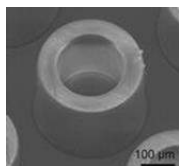

Fig. 1: SEM image of a microcontainer

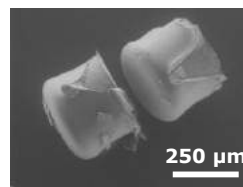
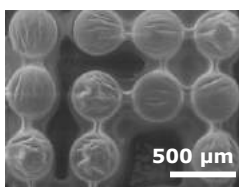

Fig. 2: SEM image of coated vaccine-loaded microcontainers

References: [1]: C. Foged, *Ther. Deliv.* 2 [8] (2011): 1057–77; [2]: S. Rizwan et al., *Eur J Pharm Biopharm.* 79 (2011): 15-22; [3]: LH. Nielsen et al., *Int. J Pharm.* 504 (2016): 98-109; [4]: C. Mazzoni et al., *J Control Release*, 268 (2017): 343-351; [5]: LH. Nielsen et al., *Eur J Pharm Biopharm.*, 118 (2017): 13-20

Session

H

Laptop Presentations

See session details and schedule on
www.sustain.dtu.dk



Photovoltaic subretinal implants for blind patients

[Rasmus Schmidt Davidsen](#)^{1*}, Toke Bek², Stephan Sylvest Keller¹, Ole Hansen¹

1: Department of Micro- and Nanotechnology, Technical University of Denmark (DTU)

2: Department of Ophthalmology, Aarhus University Hospital, *Corresponding: rasda@nanotech.dtu.dk

Background

Retinal diseases are the most frequent causes of visual loss in the Western world. Two of the prominent diseases are age-related macular degeneration (AMD) and retinitis pigmentosa (RP). The pathophysiology of AMD and RP is unknown, but a central event leading to visual loss in these diseases is the degeneration of retinal photoreceptors. At present, there are no effective treatments of photoreceptor degeneration. A promising potential solution for partial restoration of sight is to implant a solar cell that translates incoming light into an electrical signal to be transmitted to the secondary neurons in the retina [1-4]. We propose a 1-diode subretinal prosthesis design utilizing 3D electrodes made from pyrolytic carbon (Figure 1). The final device would rely on via holes between isolated electrodes (pixels) enabling sufficient nutrient flow to the cells and charge transport from each local electrode to a common return electrode on the rear of the device. A sketch of the device is shown in Figure 1 (right).

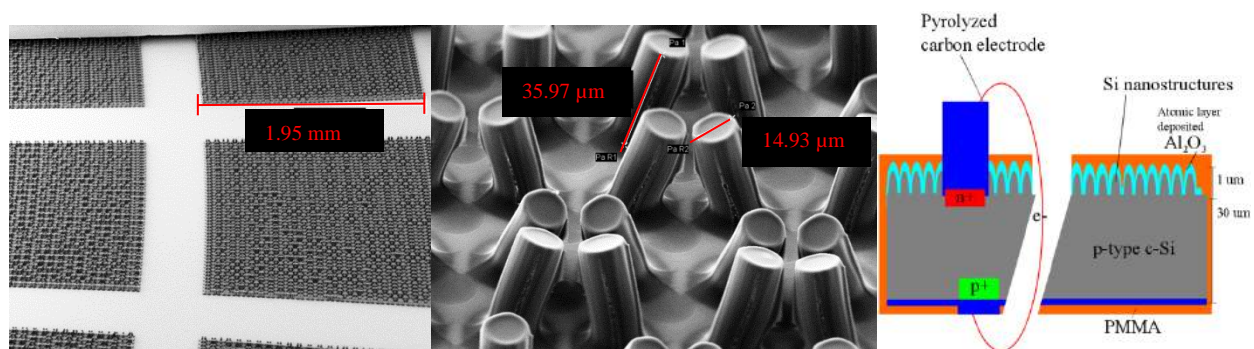

Figure 1: SEM-images of carbon electrodes at 72x(left) and 1700x(middle) and sketch of the device (right).

Fabrication of complete devices is currently ongoing and future work includes measuring potentials from porcine retinal tissue when the photovoltaic implant is placed in contact with tissue and illuminated with an appropriate light source in order to realize photovoltaic stimulation of neurons.

Acknowledgements

The authors gratefully acknowledge the funding support from Velux Fonden (project nr. 13891) and Young Investigator Program of the Villum Foundation, project no. VKR023438.

References

- [1] Y. Mandel, G. Goetz, D. Lavinsky, P. Huie, K. Mathieson, L. Wang, T. Kamins, L. Galambos, R. Manivanh, J. Harris, D. Palanker "Cortical responses elicited by photovoltaic subretinal prostheses exhibit similarities to visually evoked potentials" *Nature communications* 4 (2013) 1980. doi:10.1038/ncomms2980
- [2] S. Y. Kim, S. Sadda, J. Pearlman, M. S. Humayun, E. de Juan Jr, B. M. Melia, W. R. Green "Morphometric analysis of the macula in eyes with disciform age-related macular degeneration" *Retina* 22 (2002) 471–477. doi: 10.1097/00006982-200208000-00012
- [3] F. Mazzoni, E. Novelli, E. Strettoi "Retinal ganglion cells survive and maintain normal dendritic morphology in a mouse model of inherited photoreceptor degeneration" *J. Neurosci.* 28 (2008) 14282–14292. doi:10.1523/JNEUROSCI.4968-08.2008
- [4] J. L. Stone, W. E. Barlow, M. S. Humayun, E. de Juan Jr, A. H. Milam "Morphometric analysis of macular photoreceptors and ganglion cells in retinas with retinitis pigmentosa" *Arch. Ophthalmol.* 110 (1992) 1634–1639. doi:10.1001/archoph.1992.01080230134038

Session

H

Poster Presentations

See session details and schedule on
www.sustain.dtu.dk



Impact of physiological shear stress on cell association/uptake with a novel multicompartiment carrier

Maria J. York-Duran¹, Pramod K. Ek, Maria Godoy-Gallardo¹, Leticia Hosta-Rigau^{1*}

1: Department of Micro- and Nanotechnology, Centre for Nanomedicine and Theranostics, DTU Nanotech, Technical University of Denmark, Building 423, 2800, Lyngby, Denmark.

*Corresponding author email: leri@nanotech.dtu.dk

The development of multicompartiment carriers is an increasingly expanding area of research due to the numerous advantages offered over classical drug delivery vehicles. In particular, a compartmentalized structure guarantees the co-localization of several (incompatible) drugs at the target site by encapsulating each drug in separated compartments within the same carrier.^[1]

From a different perspective, despite the extensive research over several decades on the development of drug delivery vehicles, only a handful of platforms have reached either clinical trials or the market.^[2] This fact evidences an underlying poor transition from traditional *in vitro* to *in vivo* studies. A potential solution would be to make use of *in vitro* set ups that better mimic the human physiology thus resulting in a reduction of expensive and complex animal studies along with an experimental outcome more relatable to *in vivo* experiments. Several studies have demonstrated that the mechanical forces, such as shear stress, generated by the dynamics of the human physiology, i.e blood flow or interstitial fluid flow in tumors, highly impact the cell-carrier interaction in terms of cytotoxicity, targeting efficiency, etc.^[3]

Aiming to demonstrate the impact of physiological shear stress on the cell-carrier interaction, we developed a novel multicompartiment carrier with a functionalized surface to achieve stealth carriers (less cellular uptake) to which three relevant cell lines, i.e macrophages, endothelial and cancer cells, were exposed under the presence or absence of shear stress mimicking the physiological conditions of veins, capillaries and tumors.

Our results demonstrated that the cell-carrier association or uptake of the functionalized or non-functionalized carrier is highly dependent on the presence or absence of shear stress, the intensity of the shear stress as well as on the cell line. Different results were obtained in terms of the efficacy of the coating. Thus, shear stress should be considered when developing a drug delivery vehicle by including it in *in vitro* set ups using microfluidic devices.

- [1] M. J. York-Duran, M. Godoy-Gallardo, C. Labay, A. J. Urquhart, T. L. Andresen, L. Hosta-Rigau, *Colloids Surf., B* **2017**, *152*, 199.
- [2] C. Zylberberg, S. Matosevic, *Drug Deliv.* **2016**, *23*, 3319.
- [3] M. Godoy-Gallardo, P. K. Ek, M. M. T. Jansman, B. M. Wohl, L. Hosta-Rigau, *Biomicrofluidics* **2015**, *9*, 52605.

Artificial Organelles: Intracellular Sub-compartmentalized Microreactors to Conduct Enzymatic Cascade Reactions

Maria Godoy-Gallardo¹, Cédric Labay¹, Vasileios D. Trikalitis¹, Paul J. Kempen¹, Jannik B. Larsen¹, Thomas L. Andresen¹, and Leticia Hosta-Rigau^{*1}

1: Department of Micro- and Nanotechnology, Technical University of Denmark, Denmark.

*Corresponding author email: leri@nanotech.dtu.dk.

Cell organelles entrap a set of enzymes to achieve specific reactions within confined sub-compartments. Cell disorders can be treated by replacing malfunctioning organelles by artificial ones. Although several attempts have been made to encapsulate enzymes within carriers, only a few have succeeded employing a multiple-compartment system.¹⁻³ The aim of the present study is to demonstrate that a multistep pathway could be conducted intracellularly by employing a capsosomes which consist of polymer capsules entrapping liposomes as sub-compartments.

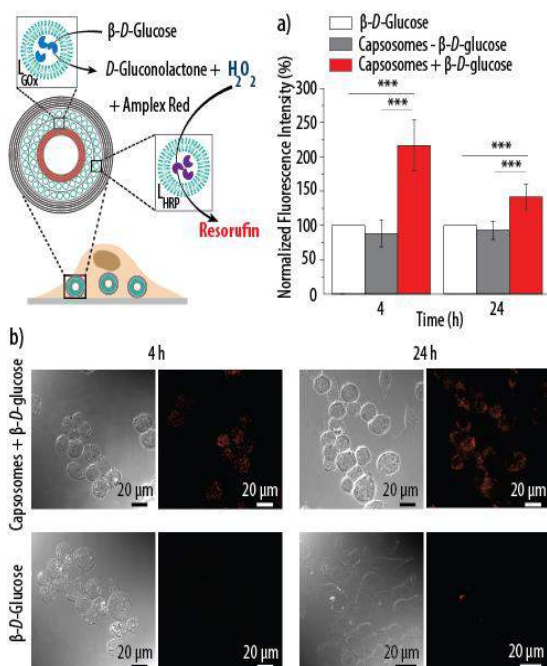

Intracellular activity of capsosomes containing enzymeloaded Liposomes. (a) Fluorescence intensity of the enzymatic cascade conversion by fluorescence spectroscopy. (b) Differential interference contrast (DIC) and confocal laser scanning (CLSM) microscopy images.

Glucose oxidase (GOx) and horseradish peroxidase (HRP) were encapsulated within separated liposome compartments of capsosomes in order to conduct a bienzymatic cascade reaction. Briefly, the β -D-glucose substrate is converted into D-gluconolactone and H_2O_2 , which is used by HRP to convert the substrate Amplex Red into the resorufin fluorescent product. In order to perform the enzymatic reaction intracellularly the cell uptake of capsosomes by a macrophage cell line was assessed by flow cytometry and confocal laser scanning microscopy (CLSM). After confirming the successful internalization of the carriers, we verified their functionality by incubating the cells with the internalized capsosomes with β -D-Glucose and Amplex Red for 4 and 24 h. The conversion into the fluorescent resorufin inside the cells was confirmed by fluorescence intensity measurements and by CLSM. Furthermore, capsosomes were able to perform multiple rounds of enzymatic cascade reactions. Therefore, it was demonstrated the capsosomes re-usability and their ability to conduct enzymatic reactions in a continuous and sustained manner, a crucial issue for the creation of successful artificial organelles that are to perform as “cell implants” inside the body.

REFERENCES: [1] Paleos, C et al. *Controlled Release* 2013, 170 (1), 141–152. [2] Peters, R. J. R. W et al. *Angew. Chem., Int. Ed.* 2014, 53 (1), 146–150. [3] Hosta-Rigau, L et al. *ACS Appl. Mater. Interfaces* 2014, 6 (15), 12771–12779

ACKNOWLEDGMENTS: This study was supported by Lundbeck Foundation (R163-2013-15402), and by a MOBILEX postdoctoral grant (5054-00081B).

Microfabrication of grating for X-ray phase contrast imaging

Chantal Silvestre^{*1,2}, Jens H. Hemmingsen¹, Erik S. Dreier³, Jan Kehres³, Ole Hansen¹

1 DTU Nanotech, Technical University of Denmark, Kgs. Lyngby, DK-2800, Denmark

2 DTU Danchip, Technical University of Denmark, Kgs. Lyngby, DK-2800, Denmark

3 DTU Physic, Technical University of Denmark, Kgs. Lyngby, DK-2800, Denmark

*Corresponding author email: chasil@nanotech.dtu.dk

X-ray absorption imaging is a technique extensively used in medical diagnosis since William Röntgen first discovered it in the late 19th century. This method is today used in medical science as well as in industry or research. However, in many circumstances, there is a need to distinguish between different media, which do not have a large absorption contrast, such as cancerous cells and healthy tissue. X-ray phase contrast imaging (XRPCI), demonstrated in the early 2000s by Momose et al. [1], is a powerful technique that enhances contrast of similar media, with only low absorption contrast. This technique has gained interest due to its ability to work with simple laboratory X-ray sources as opposed to highly coherent beam synchrotron facilities.

In our research, we focus on the fabrication methods of X-ray gratings for phase contrast imaging systems. In the quest to reduce the fabrication cost of these X-ray systems, and especially the optics, we are investigating the possibility to use tungsten as base material for the grating. When compared to gold, which is commonly used in X-ray optic, tungsten has similar X-ray absorption while it is significantly cheaper; thus, tungsten is an ideal candidate material to lower cost of the optical elements. We use laser ablation in air to pattern tungsten sheets. This technique allows to pattern holes and lines down to few micrometers in dimension. Using this technique, we have previously succeeded to pattern 1D gratings with $27 \pm 1 \mu\text{m}$ line width in a $50 \mu\text{m}$ thick W substrate. However, line pattern gratings requires a 90 degree rotation in order to obtain a full 2D image of a sample as shown in Figure 1, thus increasing the time and complexity of the acquisition. In order to overcome these concerns we have fabricated 2D gratings consisting of an array of $17 \mu\text{m}$ diameter holes as shown in Figure 2. Preliminary results (Figure 3) show that a combination of thicker substrate and smaller holes is needed in order to enhance the signal to background ratio and improve the resolution. We are currently working on the fabrication of a tungsten grid with smaller holes on $200 \mu\text{m}$ thick tungsten substrates using laser ablation.

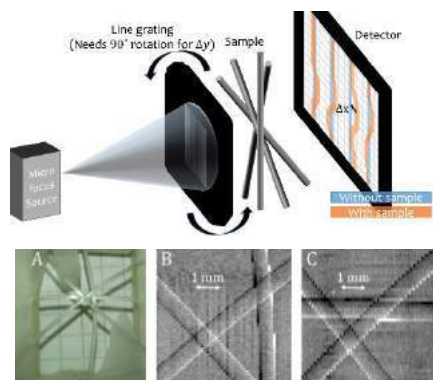

Figure 1. Top: Single grating phase contrast setup under development at DTU Physics. Bottom: (A) Fishing line used as sample in the DTU Physics setup. (B) Horizontal and (C) vertical X-ray phase contrast images obtained using a 1D grating with $27 \mu\text{m}$ line width tungsten at a source voltage of 75 kV.

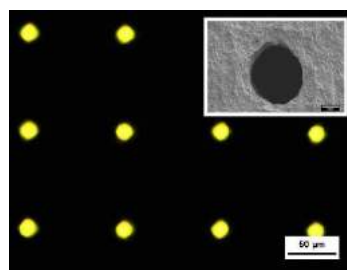

Figure 2. Microscope dark field image of a $2 \times 2 \text{cm}$ 2D holes grating made in $50 \mu\text{m}$ thick tungsten substrate using laser ablation. Insert: SEM image of $17 \pm 0.5 \mu\text{m}$ \varnothing holes. Scale $5 \mu\text{m}$.

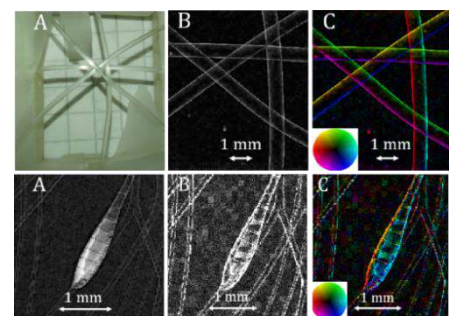

Figure 3. Result obtained with a 2D grating on $50 \mu\text{m}$ thick tungsten.

TOP: (A) Fishing line photograph; (B) Phase contrast image - absolute beam deviation, (C) Directional deviation.

BOTTOM: Antenna of a moth on top of wing exoskeleton (A) Standard attenuation (absorption) image; (B) Phase contrast image, and (C) Directional deviation

[1] A. Momose et al., Jpn. J. Appl. Phys. **42**, 866-868, 2003.

Development of silk fibroin weft-knitted fabric for tissue engineering applications

Sanaz Khademolqorani^{1,2}, Fatemeh Ajallouei¹, Ioannis Chronakis¹, Hossein Tavanai^{*3}

1-Research Group for Nano-Bio Science, Technical University of Denmark, Kemitorvet, 2800 Kgs. Lyngby, Denmark

2- Department of Textile Engineering, Isfahan University of Technology, Isfahan 84156-83111, Iran

3- Department of Textile Engineering, Center of Excellence in Applied Nanotechnology, Isfahan University of Technology, Isfahan 84156-83111, Iran email: tavanai@cc.iut.ac.ir

Tissue engineering as an interdisciplinary major is used to produce the assembly tissue for native substrate that is damaged by diseases. The general principle of tissue engineering is providing a three dimensional construct that is biologically, structurally and mechanically similar to the organs that is to be replaced. Most studies in the field of tissue engineering have focused on developing scaffolds with improved biocompatibility and cell interaction [1, 2]. However, biomechanical simulation of target tissue has been ignored. Among many natural and synthetic polymers, silk fibroin protein has shown good biological features like biocompatibility and biodegradability, as well as good mechanical properties that are expected in tissue engineering [3, 4]. In this study, we fabricated and characterized a naturally-derived scaffold with superior mechanical properties including high strength and viscoelasticity for engineering of soft tissues which were subject to mechanical loads or frequent cycles of loading/unloading.

Fine silk filaments were prepared and fabricated with knitting technique. Of all different fabrication methods, the knitting technique was chosen because of special structure with interlocking loop which presents elastic properties. Single jersey circular machine (Falmac, E 22, 16" diameter) was used for knitting. Then the glue-like silk sericin protein was degummed with alkaline solution. Directional uniaxial tensile cyclic tests (30 cycles) were performed on samples from both directions of scaffold (courses and wales). The different strain amplitudes applied for tests are 10 to 100% with intervals of 10.

According to the result, our proposed scaffold exhibited an excellent recovery behavior after each loading/unloading test. Also the result of rupture test displayed high extensibility with elastic modulus around 2.5 KPa. The breaking elongation could reach about 250% in rupture test. The findings recommend that the knitted silk scaffold is a promising candidate for practical soft tissue engineering like bladder and vessel that need tensile strength and cyclic recovery.

- 1- Fergal J. O'Brien, "Biomaterials and scaffolds for tissue engineering", *materials today journal*, vol 14, No 3, 2011.
- 2- Atala A, "Tissue engineering of human bladder", *British Medical Bulletin*, Vol 97, 2011, doi: 10.1093/bmb/ldr003.
- 3- Zi-Heng LI, Shi-Chen JI, Ya-Zhen WANG, Xing-Can SHEN, and Hong LIANG, "Silk fibroin-based scaffolds for tissue engineering", *Front. Mater. Science*, Vol7, 2013, DOI 10.1007/s11706-013-0214-8.
- 4- Banani Kundu, Rangam Rajkhowa, Subhas C. Kundu, Xungai Wang "Silk fibroin biomaterials for tissue regeneration", *Advanced Drug Delivery Reviews*, Vol 65, 2013, <http://dx.doi.org/10.1016/j.addr.2012.09.043>.

Session

L

Oral Presentations

See session details and schedule on
www.sustain.dtu.dk





INUNDO: A network based Danish think tank concerned with rising sea level and flooding

Jens Rønnow Lønholdt ¹

1: LYCEUM Innovation and Process Consultancy.

*Corresponding author email: lonholdt@lyceumconsult.dk

A lot of research and development is currently undertaking in relation to the causes, consequences and the possible counter measures of rising sea level and flooding. Covering hard technical solutions as well as softer processes, organisational, and public awareness and participation issues. A large amount of research, experiments, pilot projects, and data, are available. However, not sufficiently compiled, holistic and cross-cutting processed, exchanged, and last but not least disseminated. That is the case for Denmark as well as globally.

Sea level rising, and frequent and more stronger flooding, are undeniable. Consequences as coastal erosion, damaged infrastructure, flooding of houses, etc., are in many cases devastating, deadly, and extremely costly. Consequently we need to think smart.

We need to design public involvement processes, which will ensure, that the solutions are solid anchored with all stakeholders, and we need to design solutions, which are long-term in order to safeguard our grand as well as great grand children. This is not the case for many processes and solutions presently in Denmark, which to a large extent are local and semi-regional.

Consequently a group of Danish organisations cross-cutting universities, think tanks, consulting engineering and architectural companies, and construction companies, have jointly established the network based think tank *INUNDO*, which recently is in the process of linking up to a global initiative within the area: *International Sea Level Institute*. *INUNDO* will cover hard technical issues as well as softer issues, and aim at a national coordination function within the area.

The reason d'être for *INUNDO* is 3 fold. Firstly the need for compilation, processing and dissemination of knowledge and expertise with the aim of extracting learning points, and in this way ensuring that mistakes is not duplicated. Secondly to support and coordinate research, development, pilot and demonstration projects, in order to ensure that focus is relevant and that local solutions take into account regional as well as national perspectives. Thirdly, and based on the above, the need to establish knowledge and cooperation bridges between the institutional silos that are so frequent in Denmark, as well as globally, are imperative.

INUNDO is still in its inception and infancy. It have however been able to establish an impressive and competence strong network, covering the most relevant resource centers and resource persons within the area. The first task at hand will be to formulate a solid, relevant and fundable business model as all work up to presently have been funded by the partners. As the Danish municipalities have the overall responsibility of all water, and are in dire need for strategic as well as technical advice, they will be the first to benefit from the work and resources of *INUNDO*.



Characterizing Climate Change Adaptation in Copenhagen

Herle Mo Madsen^{*1}, Maj Munch Andersen², Martin Ryggaard¹ & Peter Steen Mikkelsen¹

1: DTU Environment, Bygningstorvet, Bygning 115, 2800 Kongens Lyngby

2: DTU Management, Produktionstorvet, Bygning 426, 2800 Kongens Lyngby

*Corresponding author email: hermom@env.dtu.dk

In Copenhagen, Denmark, stormwater management is linked to and almost synonymous with climate adaptation. The city has already experienced significant damages and political turbulence as a result of extreme pluvial flooding. The professionals tasked with adapting the city to the future climate work with a range of solutions from large cloudburst tunnels, to separation of the sewage, to Water Sensitive Urban Design. They work in fast pace with more than 300 concurrent climate adaptation projects in Copenhagen and Frederiksberg Municipalities alone; plus an unquantified number of projects in the surrounding municipals and on private property. Practitioners with different backgrounds are working on a multitude of parallel projects; and it is unclear how well the scope and goals of these projects are aligned. Therefore, we have investigated the current definition of climate adaptation in Copenhagen.

Interviews were conducted in two rounds. The first round focused on the context of the city innovation system, and resulted in 6 semi-structured in-depth interviews with key actors. The second round investigated three specific climate adaptation innovation and implementation cases and the actors' day-to-day processes, and resulted in 26 semi-structured in-depth interviews.

This study shows that definitions among actors are segmented. Different actors apply different event magnitudes, spatial scales and goals when developing or implementing climate adaptation, which results in ambiguity and eventually different choices of technologies. If there is not agreement among the actors on one or more of these counts, conflicts can arise. The conflicts are prominent in several activities in regards to implementation of climate adaptation, however also present in knowledge-sharing and knowledge-developing activities. These conflicts can be mitigated by a constant statement and discussion of the above-mentioned factors. The ambiguous definitions display the fact that climate adaptation is a new development in an old field of stormwater management. However, the field is in on-going development with a large momentum, leading to new technologies, processes and implementation projects that may eventually lead to major innovations at the city scale.

EnergyLab Nordhavn – Physical Implementation and perspectives

Christoffer Greisen*, DTU CEE

*Corresponding author email: cgre@elektro.dtu.dk

EnergyLab Nordhavn is a large-scale integrated research and demonstration project that contributes to the grand challenge of transforming the energy system to efficiently integrate a large share of renewable energy. The project develops solutions for a cost-effective future smart energy system that integrates multiple energy infrastructures (electricity, thermal, transportation) and provides an intelligent control of subsystems and components – providing necessary flexibility for efficient utilisation of renewable energy. The project results are based on combining a number of elements established in Copenhagen's Nordhavn, one of the largest development districts in Europe.

With a diverse set of such elements in the electrical and heating grids, in the built environment, and with a dedicated showroom, the EnergyLab Nordhavn project is establishing a living laboratory and an environment for strong research-based innovation in smart energy technologies, innovative business models and energy management tools for the future sustainable low-energy city districts.

Particularly exciting is the synergy between

- Possible new regulation, tariffs and energy subscriptions
- Heat pumps, flexible heat consumers, home automations systems and a grid connected battery
- The showroom and a venue for co-creation.

EnergyLab Nordhavn partners are DTU BYG, DTU MEK, DTU CEE, Københavns Kommune, Radius Elnet, HOFOR, By&Havn, ABB, Danfoss, Balslev, MetroTherm, Glen Dimplex, CleanCharge and the PowerLab facilities.

The project has a total budget of € 19 mio, of which € 11 mio are funded in two rounds by the Danish Energy Technology Development and Demonstration Programme (EUDP).

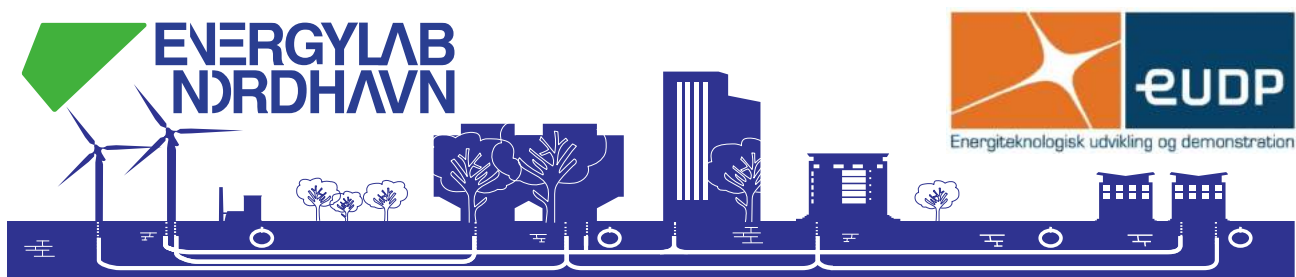

Cellular networks for reliable urban rainfall monitoring

Martin Fencel^{1*}

1: DTU Environment, bygning 115, Bygningstorvet, 2800 Kongens Lyngby, Denmark

*Corresponding author email: mafe@env.dtu.dk

Increasing urbanization makes it more and more important to have accurate stormwater runoff predictions, especially with potentially severe weather and climatic changes on the horizon. Such stormwater predictions in turn require reliable rainfall information. Especially for urban centres, the problem is that the spatial and temporal resolution of rainfall observations should be substantially higher than commonly provided by weather services with their standard rainfall monitoring networks. Commercial microwave links (CMLs), pairs of telecommunication antennas, are non-traditional sensors, which have been proposed about a decade ago as a promising solution. CMLs are attenuated by raindrops and the attenuation rate is almost linearly related to the rainfall intensity (Messer et al., 2006).

This contribution presents results of two case studies showing the advantages and limitations of the CML rainfall estimation in the context of urban drainage modelling. The CMLs perform well especially during heavy rainfalls with high space time variability. A CML network is very well suited for urban rainfall monitoring especially in bigger cities where CML lengths correspond to the length scale of subcatchments. CML networks in smaller cities are less dense and CML lengths tend to be here longer which leads to spatial averaging of rainfall peaks. Nevertheless, even here CMLs provide valuable additional rainfall information which can improve rainfall-runoff modelling. The data are technically easily accessible from mobile phone operator's network management centre. The main constraint is currently in finding a suitable business model which would motivate operators to share the CML data also for other than experimental purposes.

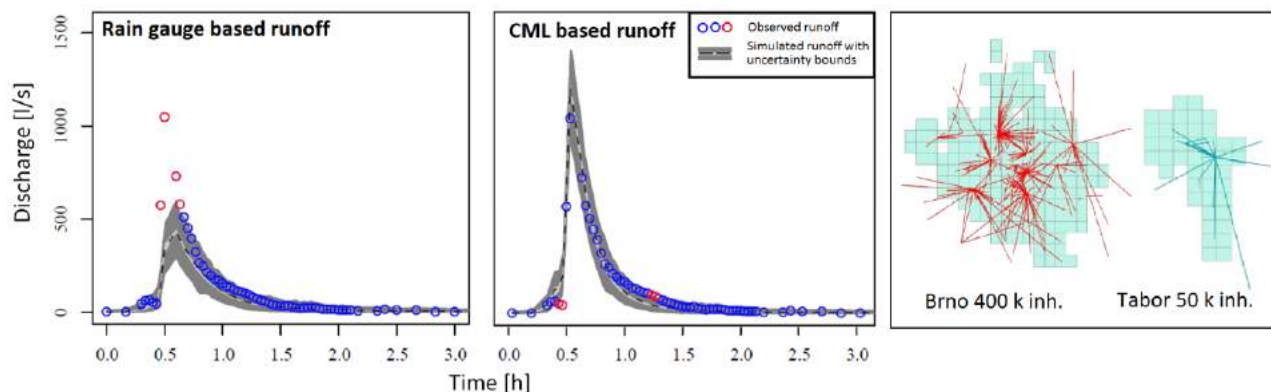

Fig. 1 – Left and middle: Runoff simulated based on three rain gauges about 2.5 km from the catchment located in Prague (CZ) in comparison to the runoff simulated from CMLs. Blue circles depict observed runoff inside of uncertainty bounds whereas red circles are outside of them. Right: CML topology in a city with 50 and 400 thousand inhabitants.

References:

Messer, H., Zinevich, A., Alpert, P., 2006. Environmental Monitoring by Wireless Communication Networks. *Science* 312, 713–713. <https://doi.org/10.1126/science.1120034>

Session

L

Laptop Presentations

See session details and schedule on
www.sustain.dtu.dk



Smart Campus data system and analysis

Ole Schultz, osch@dtu.dk, Tomasz Blaszczyk tomb@dtu.dk, DTU Diplom, Section for Informatics, Center for Bachelor of Engineering Studies, Hakan Yurdakul Pedersen, Ms. Stud. hakan552_5@hotmail.com, Abdirazak Mohamud Yusuf, Ms. Stud., Abdirazak3@hotmail.com, DTU Computer Science

Introduction

Logging data as energy on sub-levels, indoor climate and weather can be the foundation for changing the daily process of operating buildings and processes more sustainable. Building management system samples a lot of data, but these are proprietary and access is not possible for students and researchers. Therefore the Campus facilities are equipped with low-cost IOT sensors. Here and at the conference we address these questions: How to utilize the energy data and indoor climate data in a Big Data analysis platform for improving a sustainable Campus? How can the small scale enterprises be involved together with students?

The system

Right now we are logging data from: Parking smart light, electrical meters, weather station, and indoor climate meters. At the conference we present the system shown in the figure below and examples on non-intrusive data loggers, some examples on analysis which can be done by zeppelin notebook[1] [2]

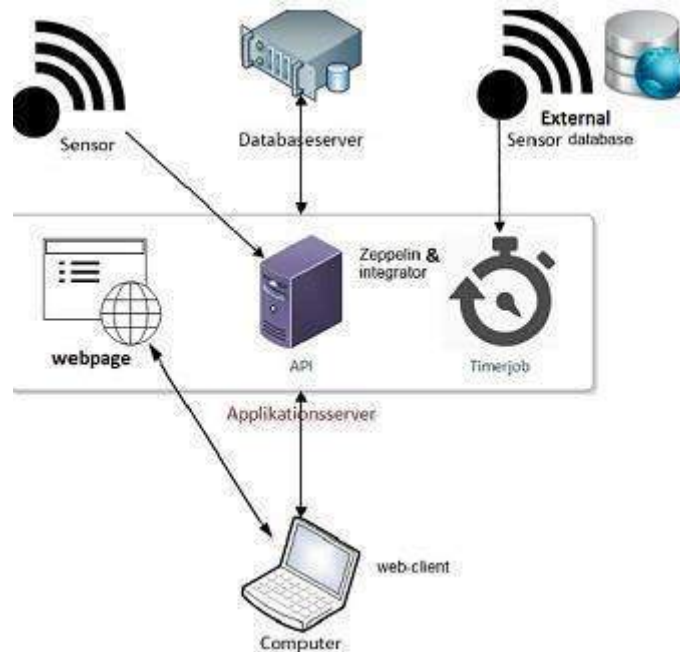

Last semester, three Bachelor of Eng. Students [3] configured the platform and developed the back-end and front-end and the sensor databases as well. The sensors were developed by the authors (osch, tomb).

This work and platform has a lot of potential and purpose for corporation with the industry and doing CDIO-projects. The system fits with the monitoring and check in energy management in ISO 150001 described in [4]. Currently, we are partner in Sustainable Production in WP41, funded by The Danish Industry Foundation, where the system is a part of the deliverables

References:

- [1] Nov. 2017. URL: <https://zeppelin.apache.org/>.
- [2] Carolyn DUBY. "Reproducible research at scale with apache spark and zeppelin notebook". Open data science conference (2017).
- [3] Hakan Yurdakul Pedersen - S133835 Nicklas Ejberg Storm Jensen - s135274 Abdirazak Mohamud Yusuf - S130599. "Data Samling". 2017.
- [4] Danish Energy agency. "Energy Policy Toolkit on Energy Efficiency in Industries Experiences from Denmark". (2015).

Session

L

Poster Presentations

See session details and schedule on
www.sustain.dtu.dk





Enhancing demand side flexibility in Nordhavn buildings for integrated multi-energy systems

Rongling Li^{*1}, Jiawei Wang², Yi Zong², Kyriaki Foteinaki¹, Carsten Rode¹

1 DTU Civil Engineering; 2 DTU Electrical Engineering

*Corresponding author email: liron@byg.dtu.dk

EnergyLab Nordhavn is a large-scale research and demonstration project based in the Nordhavn neighborhood of Copenhagen, one of the largest urban development districts in Europe (EnergyLab Nordhavn, 2015). The district functions as a living laboratory for testing smart energy technologies, business models, and operational solutions at every level – component, building, and grid. Buildings are crucial elements in smart energy solutions due to their function of coupling different energy sectors on the demand side and their considerable potential for offering flexible energy consumptions as energy system services. Energy flexibility in buildings can be distinguished in two forms: thermal flexibility and electrical flexibility.

Thermal flexibility of buildings were investigated to explore the potential services could be provided to district heating grids. Field measurements were conducted aiming to find a solution to eliminate the use of peak load boilers in the heat production. The results indicated that residential buildings had large thermal flexibility potential as the supply water temperature could be reduced significantly; however, office buildings had greater potential for heat conservation due to its greater heat demand (Sandersen, 2017). Modeling and simulation studies were carried out to investigate the thermal flexibility of various building designs. The thermal flexibility was strongly influenced by thermal insulation of building envelope, outdoor conditions and occupant behavior. Building thermal mass was found to be influential only if the thermal resistance of the envelope was sufficient (Sarran, 2016). Floor heating system was found to be the most flexible system in comparison with radiator heating and air heating (Zilio, 2016).

To achieve 100% renewable energy generation by 2050 in Denmark, electrical flexibility is required in order to ensure a reliable and balanced power system operation during variation of renewable energy generation (Ma, 2013). Besides the smart grid-oriented demand response program running with appliances in residential buildings, the electrical flexibility through buildings can be realized by utilization of electrically driven heating units, e.g. heat pumps and electric boosters. The demand side flexibility provided by cross-energy sectors can contribute to higher renewable energy penetration (Yi, 2016 & 2017). The simulation results of an economic model predictive control-based energy management system for the heating system in the apartments of the Nordhavn area show that the flexible consumption and integrated multi-energy systems must be developed with correlative dependence and interplay to meet the challenge of integrated fluctuating renewables.

Sandersen, 2017. Thermal flexibility in different building in a district heating network.

Sarran, 2016. Impact of building design parameters on energy flexibility in Nordhavn district.

Zilio, 2016. Analysis of building services systems for flexible operation of buildings in smart city district Nordhavn.

EnergyLab Nordhavn, 2015. <http://www.energylabnordhavn.dk/>

Ma, 2013. Evaluating and planning flexibility in sustainable power systems

Yi, 2017. Enhancing Wind Power Integration through Optimal Use of Flexibility in Multi-Carrier Energy Systems from the Danish Perspective

Yi, 2016. Challenges of implementing economic model predictive control strategy for buildings interacting with smart energy systems

Application of the UN SDG's in Architectural Engineering

Orfanidou Timokleia¹, Birkved Morten²

1: Department of Civil Engineering, Technical University of Denmark

2: Department of Management Engineering (QSA), Technical University of Denmark

*Corresponding author email: s155592@student.dtu.dk

In 2015, United Nations set an agenda called "Transforming Our World: the 2030 Agenda for Sustainable Development", this agenda is adopted by more than 150 world leaders. Specifically, in paragraph 51 the 17 Sustainable Development goals are presented with their correlated 169 targets. Civil Engineering is an essential contributor for the achievement and delivery of policies for Sustainable Development. Sustainable Development can be studied by examining various categories as: environmentally friendly design, procurement, construction methods, and management procedures (Opoku, 2016).

At the moment, building and construction industries are the larger consumers regarding natural resources (land use and material extraction), and score 30-40% of global primary energy and greenhouse emissions (Kallaos, 2010). Built environment is greatly connected with the progress of the society, therefore the sustainable built structures is an outcome of meaningful development and reliable engineering. Vital element for the achievement and implementation of the UN SDG's is to acquire and communicate the relevant knowledge. Concerning built structures, the life cycle categories from where the largest effects originated from are: construction, use, maintenance, and decommissioning of buildings and infrastructure (Kallaos, 2010).

.According to this, the areas in which the environmental impacts should reduce are: energy, carbon, waste and water. This presentation will provide an overview on how to quantitative approach the UN SDG's in Civil Engineering, and more specific from an LCA point of view.



1- Illustration of how the built environment can support the UN SDGs. (World Green Building Council, 2017)



Environmental impacts of electric vehicle deployment in Copenhagen for 2016-2030

Florence Alexia Bohnes^{1*}, Jay Sterling Gregg² and Alexis Laurent¹.

1: Division for Quantitative Sustainability Assessment (QSA), DTU Management, DK.

2: Division for System Analysis, DTU Management, DK.

*Corresponding author: flbo@dtu.dk

The current transport sector is an important contributor to multiple environmental impacts, such as climate change and resource depletion. Recent technological advancements seek to provide more environmentally sustainable urban mobility. Life cycle assessment (LCA) is a widely used tool that quantifies the potential environmental impacts of systems in a life cycle perspective, and it can be applied to transport systems to ensure that these developments reduce the impact on the environment. In that dynamic, we conducted an LCA of the passenger fleet of Copenhagen between 2016 and 2030, and tested different scenarios of electric vehicles (EVs) deployment at urban scale over that time scope. Five different types of powertrains with characteristics corresponding to the actual vehicles in Copenhagen were modelled and compared, before being integrated in four fleet-based scenarios describing the evolution of the entire passenger fleet during 15 years. The major components of the transport system, i.e. the vehicles, the charging infrastructures and the electricity and fuel support systems, were differentiated in time. At the vehicle-level, fuel-cell EVs appear to have the lowest environmental impacts in ten categories, and the highest only in ozone depletion. Range-extended EVs emerge as a promising transition technology on the way to full electrification. At fleet-level, the charging infrastructures have a limited contribution to the total impacts compared to the vehicles and the energy systems. The four scenarios assessed present different ranking in the 15 impacts categories that were considered, but one of the scenarios promoting disruptive technological advances related to fuel cells EV, stand out as the most environmental-friendly option. Even though these results are only applicable to Copenhagen, they support the recommendation that technology developers and decision-makers should push the development and deployment of fuel-cell and range-extended EVs. Overall, this case study has illustrated which useful insights can be gained from applying LCA in the field of transportation, and we recommend its use in the assessment of new transport policies at urban and regional scales to ensure the actual reduction of environmental impacts and avoid burden-shifting from one environmental impact to another.

Assessment of physical and ecological space consumed by transport modes: A case of Rajkot city India

Marie-Eve Will*¹, Yannick Cornet², Talat Munshi³

1: Transport DTU, DTU Management Engineering

2: Transport DTU, DTU Management Engineering

3: UNEP DTU Partnership, DTU Management Engineering

*Corresponding author email: marie.eve.will@gmail.com

The space needed by various urban passenger transport modes varies greatly depending on the size and the speed of the vehicle. Past studies have shown that public transport and non-motorized transport can be up to 20 times more space-efficient compared to a typical car. This is of particular relevance in urban context where space is a constrained resource. Yet space used by transport modes is rarely assessed in the transport planning practice and there exists no standard method for quantifying the use of space in complex urban settings like that of developing cities. This study proposes a method based on the space-time concept for quantifying the transport, parking and ecological space and compare them by modes. This is done with the purpose to showcase the spatial benefits of promoting non-motorized transport (NMT) and public transport modes. Transport planning scenarios developed for the Low-carbon Comprehensive Mobility Plan (LCMP) (1) prepared for the city of Rajkot are used to demonstrate the method. The indicators show that significantly less space is used by transport in a scenario that promotes higher use of public transport and NMT mode in comparison to business-as-usual scenario. This provides evidence that could contribute to alleviating chronic congestion expected from a car- and motorcycle-based transport development only. This research participates in creating an assessment framework for low carbon transport development that would include spatial efficiency concerns.

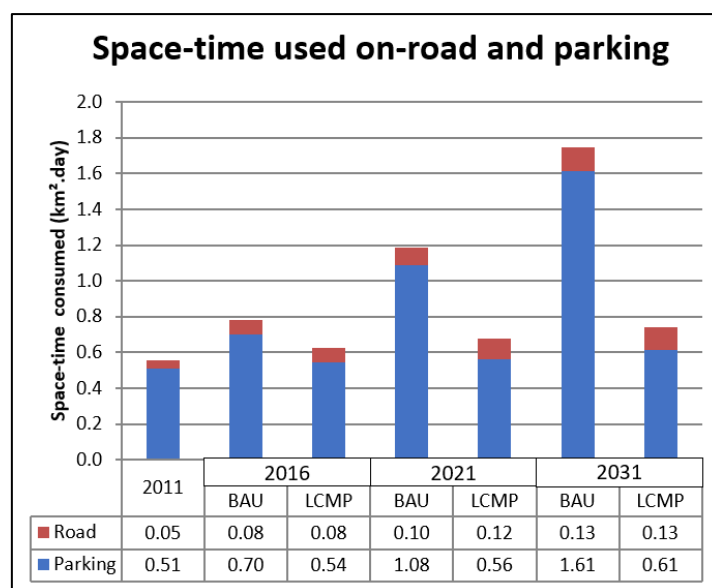

(1) Munshi, T., K. Shah, A. Vaid, V. Sharma, K. Joy, S. Roy, D. Advani, and Y. Joseph. *Low-Carbon Comprehensive Mobility Plan: Rajkot*. 2014.

Thesis: Absolute Sustainability from a Circular Architectural Perspective

Katja L. Frankvard¹, Amalie C. Nyholm², Morten Birkved^{*3}

1: DTU Civil Engineering *Corresponding author email: birk@dtu.dk

The building industry is responsible for around 30 % of the overall consumption and global resources, and almost 50 % of the global energy use¹. With such a big influence on the global climate impacts, is it obvious that this industry's building methods have to be rethought and reformed if our world has to develop toward a more sustainable future. But what does sustainable development or sustainability mean and how can we reach a sustainable future?

To find an answer or to find a path that will lead to different solution scenarios, this thesis will investigate *to what extend absolute architectural sustainability is achievable in a Danish circular perspective?*

There is no definite consensus about what absolute sustainability is and how it is defined, within all three dimensions of sustainability: Environmental, economic and social sustainability. Therefore this thesis will try to work towards a definition of 'absolute sustainability' in an architectural circular perspective.

In this thesis 'absolute sustainability' is achieved when all of the three parameters: Environmental, economic and social sustainability, are *equally present without compromising their own sustainability*. The complexity of multidimensional architectural sustainability is addressed through a lifecycle perspective at city, building and component scale.

The UN Sustainable Development Goals are used as indicators of sustainability and are related to the used methodology within environmental, economic and social sustainability.

Two cases will be assessed through both quantitative and qualitative indicators of sustainability, that are divided into three main assessments:

1. Life cycle assessment (environmental)
2. Life cycle cost (economic)
3. Social effect (social)

All assessments will be performed at building scale with focus on social housing. The environmental and economic assessments will assess the sustainability through a lifecycle perspective, where the social assessment will focus on the use-phase of the building's lifecycle.

The results will be expressed as an indication of 'absolute sustainability' through the use of Kate Raworth's Oxfam Doughnut². Three 'doughnuts' will be presented as a result of the environmental, economic and social evaluations.

The results will lead to suggestions for changes and improvements on how to ensure a path towards absolute sustainability in the future Danish building industry at building scale.

¹ <http://blog.dgnb.de/en/saving-the-world-the-dgnbs-contribution-to-the-united-nations-sustainable-development-goals/>

² <https://www.kateraworth.com/doughnut/>

Comparative LCA of repairing flooded houses versus construction of a dam

Thomas Hennequin¹, Hjalte Jomo Danielsen Sørup^{1,2}, Yan Dong^{2,3}, Karsten Arnbjerg-Nielsen^{1,2}

1: DTU Environment (tthen@env.dtu.dk, hjds@env.dtu.dk, karn@env.dtu.dk)

2: DTU GDSI - Global Decision Support Initiative

3: DTU Management Engineering (yado@dtu.dk)

Coastal ecosystems and human infrastructures are under the constant threat of floods. Accounting for half of the natural disasters [1], flooding is amongst the most impactful calamity. Moreover, Sea Level Rise (SLR) is expected to locally increase the risk and resulting damage of these events. SLR will increase both flood frequency and depths in most of the world, even though the effect is not geographically uniform. In the case of northern Europe (Baltic and North Seas), a relative expected SLR up to 80cm is expected [2]. Combined with a growing urban density of inhabitants and infrastructures, this makes flood risk a rapidly growing concern for society that demands focus.

A range of solutions for protecting and mitigating flood risk in cities exists and numerous others are being developed. These solutions are mostly being assessed using risk assessment frameworks where risk is defined as a combination of potential economic damage and probability of occurrence. When environmental impact is included, which it seldom is, the is either done qualitatively and or with rather limited scopes. Instead, here, the analysis is made from an environmental viewpoint, using the holistic Life Cycle Assessment (LCA) framework to compare the impact of constructing a dam (cf. Figure 1) and the post-disaster repairation of houses were the dam not built.

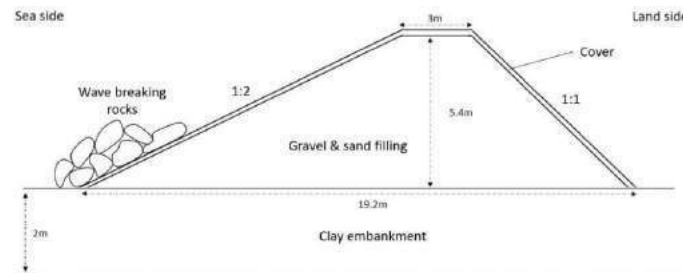

Figure 1 - Cross section of the modelled dam protecting the Avedøre Holme area in Copenhagen.

The method chosen intends to reconcile the fields of environment assessment and risk assessment. To do so, LCA is paired with a probabilistic approach, namely a Monte Carlo analysis. The SLR related water levels yielded by the simulation are fed into an environmental impact calculator. Then, the resulting probability densities, for each category, are compared to the impact of building the dam. Finally, the probability of having a positive environmental bill is deduced. This methodology is applied to two case studies in Copenhagen and northern Zealand with a time scope of a century.

Preliminary results indicate that the solution of the dam, in either case, is largely preferable. Indeed, with SLR, the number of damaging storms goes skyrocketing to the point where a dam seems necessary unless all the houses concerned are planned to be relocated in the next twenty years or so.

[1] D. Guha-Sapir, "2016 preliminary data1: Human impact of natural disasters," 2016.

[2] A. Grinsted, S. Jevrejeva, R. E. M. Riva, and D. Dahl-Jensen, "Sea level rise projections for Northern Europe under RCP8.5," *Clim. Res.*, vol. 64, no. 1, pp. 15–23, 2015.

Methods of improving the performances of the low-temperature district heating system

Xiaochen Yang^{1*}, Svend Svendsen¹

1: Department of Civil Engineering, Technical University of Denmark

* Email: xiay@byg.dtu.dk

According to the energy guideline of European Union, the overall primary energy consumption needs to be reduced by 1/3 compared to the current, while the proportion of the renewable energy usage should be increased. The heating demand, which plays a role in the overall energy consumption, thus should be supplied more efficiently. With district heating, it is possible to aggregate large-scale excess heat from industry or waste heat for heating purpose. Nowadays, the district heating system are experiencing a transition towards the 4th generation district heating (low-temperature district heating), which will be operated mainly at 50-55 °C as supply temperature and 25 °C as return temperature[1]. That means more low-temperature renewable energy sources will be accessible. But how to provide sufficient heat without violating any comfort and hygiene requirements is crucial for the new generation district heating.

The local substation is used to harmonize the parameters between the primary side and secondary side. The optimization of the substation is helpful to remove the temperature or hygiene restrictions of low temperature district heating (LTDH), enhance the stability of the heat supply, and create synergy with the power grid. Considering the features of different district heating systems and building typologies, different methods to improve the performance of the district heating system are proposed.

1. Flat station for the newly-built buildings, LTDH can be used as heat supply. Since domestic hot water is produced locally, the hygiene risk of low DH supply temperature can be eliminated. Such type of substation has good energy and exergy performances.
2. Low temperature or ultra-low-temperature district heating with local supplementary heating devices is preferred for low-heat-density area due to lower relative system heat loss. Different heating devices can be considered for this combination, such as electric tracing, electric booster, electric micro tank concept. Their performances and comparisons have been studied in the authors' previous work[2]xi. Moreover, the low-temperature renewable energy sources can be beneficial with lower fuel costs. Thus, even excess electricity is consumed, it is still possible to achieve better performance compared to the conventional medium temperature district heating.
3. The optimized control method and design for the heating devices should be a general solution for the improvement in the substations. The over dimension and bad control of the equipment are the main problems. For example, an oversized charging flow of the storage tank will heat the storage tank frequently, which will result in too high district heating return temperature, especially during the period with low-tapping or non-tapping period. However, by optimizing the charging flow, the tank can be heated gradually during the day and the DH flow can also be cooled down efficiently. For the building with large domestic hot water circulation system, a more robust solution can be developed by installing a circulation heat pump between the storage tank and circulation circuit.

Reference

- [1] H. Lund, S. Werner, R. Wiltshire, S. Svendsen, J. E. Thorsen, F. Hvelplund, and B. V. Mathiesen, "4th Generation District Heating (4GDH). Integrating smart thermal grids into future sustainable energy systems.," *Energy*, vol. 68. pp. 1–11, 2014.
- [2] X. Yang, H. Li, and S. Svendsen, "Energy, economy and exergy evaluations of the solutions for supplying domestic hot water from low-temperature district heating in Denmark," *Energy Convers. Manag.*, vol. 122, pp. 142–152, 2016.

Simple control rules for mitigating N₂O emissions in phase isolated full-scale WWTPs

Sara Eskström^{1*}, Anna Katrine Vangsgard², Romain Lemaire³, Borja Valverde-Pérez^{1*}, Marlene M. Jensen¹, Benedek G. Plósz¹, Dines Thornberg⁴ and Barth F. Smets^{1*}

¹Department of Environmental Engineering, Technical University of Denmark, Denmark

²Krüger A/S, Denmark

³Technical & Performance Department, VEOLIA, France

⁴BIOFOS, Denmark

*Corresponding author: bvape@env.dtu.dk; bfsm@env.dtu.dk

Nitrous oxide (N₂O) is a strong greenhouse gas (GHG) and ozone depleter, with a warming potential 300 times higher than carbon dioxide (CO₂). 1.2% of the total anthropogenic N₂O emission is believed to originate from the wastewater treatment (WWT) sector. Conventional biological nutrient removal processes are known to produce N₂O. A one year long-term study of N₂O production and emissions was performed at Lynetten, Denmark's largest WWTP. Nitrification and denitrification takes place in 20 interconnected surface aerated reactors by alternating process conditions as well as influent and effluent flows. The long-term data revealed that N₂O emissions accounted for up to ~30% of the total CO₂ footprint of the WWTP. The highest production and emission of N₂O was occurring during nitrification phases. High ammonium concentrations and long aeration phases lead to high net N₂O production and emissions rates. High production and emissions were also associated with the afternoon loading peaks at the WWTP. During denitrification phases, N₂O was initially produced and consumed before onset of aeration. An effective control strategy was implemented, whereby N₂O emissions were reduced from 0.8% to 0.3% of the nitrogen load during the mitigation period. By applying this simple control strategy the overall CO₂ footprint was reduced in 18% compared to normal operation.

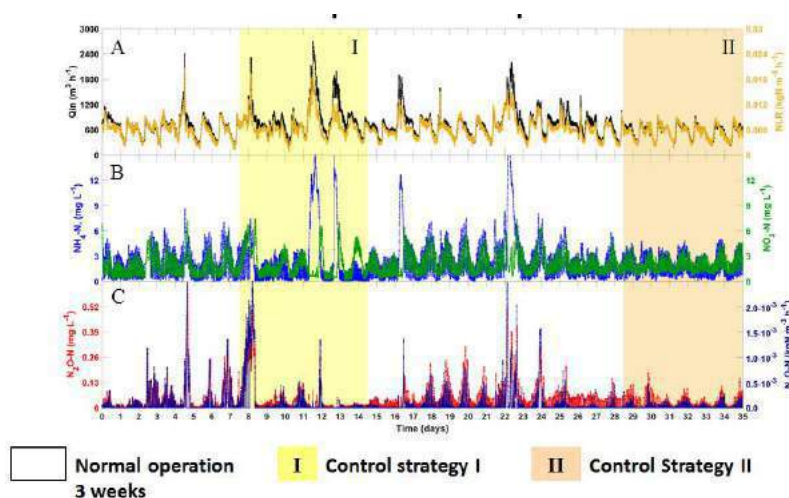

Figure 1: Performance of the Lynetten WWTP during normal operation and evaluation of control strategies.

Integrating physical pressures, hazard prevention and urban development in the COHERENT project

Morten A.D. Larsen^{1*}, Kirsten Halsnæs²

1+2: DTU, Management Engineering.

*Corresponding author email: madla@dtu.dk

The COHERENT project, funded by Innovation Fund Denmark, was instigated on Nov. 1 and addresses risks in the coastal zone of both natural and anthropogenic origin and the interplay between them. The project is highly multidisciplinary spanning natural, social and economic sciences as well as time scales from the immediate hazard response to longer term adaptation and management and with a high degree of cross-work package dependencies and coordination. This enables a 'COHERENT' approach in line with the session topic of 'smart livable cities.

The presentation will focus on the impact of inland/watershed hydrology on natural hazards in the coastal zone, most often flooding events on coastal cities, and the interactions with adaptation practices, urban development and management. The topic is highly relevant due to projected increases in frequencies and magnitudes of natural hazards in the coastal zone under current climate change potentially resulting in high social and economic costs.

The physical impact of coastal flooding is made up of mainly the impact of the storm surge itself as well as waves, tides and a general increase in sea level and the assessment of potential adaptation measures can be complex. The vulnerability can however increase for the fluvial part with higher stream flow and groundwater level, with temporal scales in the order of days to seasons. Another influence comes from the pluvial side when rainfall events occur simultaneously, with temporal scales in the order of minutes to days. A key objective of the work is therefore to assess the influence of inland-watershed hydrology on the risk hazards for current and future conditions within the three cases of the project; Skive, Ringkøbing and Aabenraa municipalities. A key objective is a close interaction with municipalities and stakeholders to reflect applied conditions and assess true projected urban development goals.



Session

M

Oral Presentations

See session details and schedule on
www.sustain.dtu.dk



Sustainable solar fuels and electricity through discovery and prototyping of new materials

Andrea Crovetto^{*1}, Korina Kuhar¹, Mohnish Pandey¹, Kristian S. Thygesen¹, Karsten W. Jacobsen¹, Ole Hansen², Brian Seger¹, Peter K. Vesborg¹, Ib Chorkendorff¹

1: DTU Physics. 2: DTU Nanotech

*Corresponding author email: ancro@fysik.dtu.dk

In 2016, only 20% of the electricity produced in the world did not result in direct emission of harmful gases into the atmosphere. If one excludes hydropower, that percentage further drops to 5%. In the same year, the percentage of fuels that did not emit harmful gases upon use or production was nearly zero.¹

Nevertheless, the solar radiation power received at any instant by a very small fraction of the Earth would be sufficient to satisfy the world's electricity and fuel demand. Apart from electricity generation through the well-known solar cells, it is also possible to produce fuels (e.g. hydrogen) by splitting water electrochemically through solar energy.² Future improvement in conversion efficiency and reduction of costs calls for new materials with tailored properties.

At DTU Physics, a joint effort by computational- and experimental material scientists has resulted in massive computational screening of potential new materials for solar electricity and solar fuels. Tailored photo-absorber materials based on earth-abundant elements have been discovered, synthesized, and inserted into prototype devices. We will tell the story of the most successful material produced so far, from its speculated existence as one among many screened candidates, to its experimental "birth" in the real world and towards its maturity as an active material in solar devices.

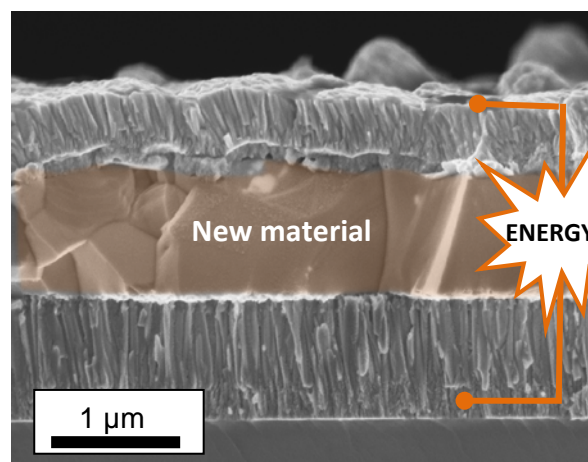
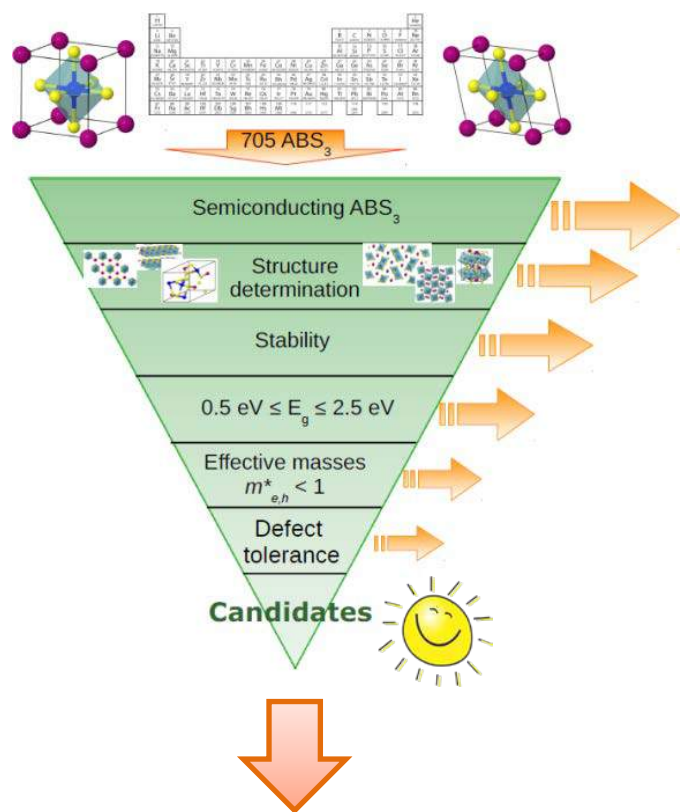

¹ Renewables 2016 Global Status Report, http://www.ren21.net/wp-content/uploads/2016/06/GSR_2016_Full_Report.pdf

² J.W. Ager, M.R. Shaner, K.A. Walczak, I.D. Sharp, and S. Ardo, Energy Environ. Sci. **8**, 2811 (2015).

Up-scaling the production of nanomaterials with customized properties: Continuous Solvothermal Flow Synthesis

Christian Kallesøe*¹, Patricia Hernández-Fernández¹, Ane K. Baden¹, Amado A. Velázquez-Palenzuela¹, Christoffer M. Pedersen¹, Hugo J. L. Silva¹, Leif H. Christensen¹

¹: Danish Technological Institute, Nano Production and Micro Analysis

*Corresponding author email: chkl@teknologisk.dk

We present here an up-scalable flow synthesis method capable of producing nanomaterials with very precise control of the particle size and spatial distribution onto high surface area substrates. Supercritical fluids are interesting because they share properties from gaseous as well as liquid phases. They offer the opportunity to manipulate different properties of the reaction media as density, viscosity or diffusivity by controlling the pressure and temperature. Our continuous solvothermal flow process allows us to bring the solvents into the supercritical phase, resulting in rapid mixing and heating of the reactants that will cause instantaneous nucleation of nanoparticles. The use of supercritical fluids in a flow enables very precise control of the nanomaterial properties, such as crystallinity, particle sizes and atomic ratios, all affecting the performance of catalysts, while minimizing material waste. Furthermore, our process facilitates the synthesis of particles directly onto different support materials, as carbon or oxides. The equipment required for the process is not readily available, thus we have designed and build our own custom process lines to handle the extreme environment of the supercritical fluids, capable of producing up to 500 g/h of nanomaterials¹.

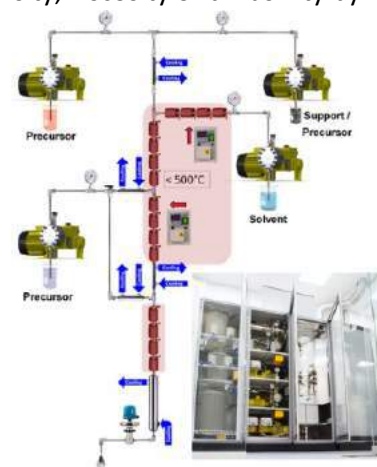

Scheme and view of the pilot-production reactor at DTI.

We have demonstrated the production of carbon supported metallic nanoparticles for PEM fuel cell applications with high activity and stability. This includes pure Pt, but also alloys such as $\text{Pt}_x\text{Ni-C}$ and $\text{Pt}_x\text{Co-C}$ catalysts² with oxygen reduction activities reaching 1.5 A/mg_{Pt} at 0.9V, surpassing by far the DOE target for 2020 of 0.44 A/mg_{Pt}³. Various oxides have also been prepared using our flow process, such as γ -alumina with very high surface areas of ca. 500 m²/g. Usually, the formation of the gamma phase requires a post-calcination step at high temperatures, raising the cost and complexity of the process, however we can produce it in a single step. γ -alumina is used for many industrial applications, e.g. as support in catalyzed diesel particulate filters and diesel oxidation catalysts. For this application, we have incorporated different metals such as Pt, Pd and Fe, resulting in very active catalysts with a significant PGM saving potential. Our method has also been used for the preparation of mixed oxides, such as ceria-zirconia doped with various lanthanides, with high crystallinity, surface area, oxygen storage capacity and stability, used as washcoat in three-way catalysts for e.g. gasoline-powered vehicles⁴.

1. WO 2014005598-A1 / WO 2015104025-A1

2. P. Strasser et. Al., Nat. Chem. 2010, 2, 454-460.

3. Fuel Cell Tech. Roadmap. June 2013. https://energy.gov/sites/prod/files/2014/02/f8/fctt_roadmap_june2013.pdf

4. E. Rohart et. Al., Top. Catal. 2004, 30/31, 417-423.

Continuous Hydrothermal Flow Synthesis of Functional Oxide Nanomaterials for Energy Conversion Devices

Yu Xu ^{*}, Philipp Zielke, Ragnar Kiebach ^{*}

Section of Mixed Conductors, Department of Energy Conversion and Storage, DTU Risø

Frederiksborgvej 399, 4000 Roskilde, Denmark

Correspondence: Y. Xu, yuax@dtu.dk, +45 9351 1148. R. Kiebach, woki@dtu.dk, +45 6131 6469

The application of continuous hydrothermal flow synthesis (CHFS) to preparing oxide nanomaterials with tailored properties has gained increasing attentions, due to its availability to a large-scale production of nanomaterials that are indispensable in many modern technology applications.¹

The presentation will be based on results of a three-year PhD project, in which CHFS was used to develop several types of oxides that are of interest to researches on solid oxide cells, oxygen permeation membranes and catalysis.

First a dual-stage flow-type reactor will be introduced that can work in either single-stage (for synthesis of single-phase materials) or dual-stage (for synthesis of nanocomposites) mode.² Results on syntheses and characterizations of $Y_xZr_{1-x}O_{2-\delta}$ (YSZ), NiO, $Gd_xCe_{1-x}O_{2-\delta}$ (GDC), $LaCrO_3$ and $Ni_xCo_{1-x}Fe_2O_4$ nanoparticles will be presented, showing a wide applicability of the CHFS technique. Further, some primary endeavors with respect to applications of synthesized nanomaterials will be presented. For instance, slurries of YSZ and NiO nanocomposites were tape casted for making fuel electrodes. Suspension of synthesized GDC nanoparticles was transferred to inks modified for inkjet printing of electrolyte films. $Ni_xCo_{1-x}Fe_2O_4$ was used as catalyst that was evaluated in the CO oxidation process and in the electrochemical oxygen evolution reaction for water splitting.

Acknowledgement

Danish Council for Independent Research is acknowledged for the funding within the *ProEco* project (DFF 1335-00138). Project partners from DTI, Aarhus University and University of Duisburg-Essen are appreciated for inspiration and cooperation.

References

- 1 J. A. Darr, J. Zhang, N. M. Makwana and X. Weng, *Chem. Rev.*, 2017, **117**, 11125–11238.
- 2 P. Zielke, Y. Xu, S. B. Simonsen, P. Norby and R. Kiebach, *J. Supercrit. Fluids*, 2016, **117**, 1–12.

Chemical solution deposition on textured metal substrates: Enabling sustainability with large-scale and flexible functional thin films

Grivel J.-C.^{1*}, Thydén K.¹, Bowen J.R.¹, Haugen A.B.¹, Wulff A.C.¹, Zhao Y.²,

1: Dpt of Energy Conversion and Storage, Technical University of Denmark

2: School of Electronic Information and Electrical Engineering, Shanghai Jiao Tong University, China

*Corresponding author email: jean@dtu.dk

The deposition of chemical solutions on textured metal substrates by means of dip-coating followed by adequate thermal treatments is a convenient way for manufacturing thin and flexible films of functional materials with a high degree of preferential orientation. This process is relatively cheap and can be scaled up to coat large areas. After an introduction to the technology based on our previous work on the manufacture of bi-axially oriented high-temperature superconducting thin films including an overview of the metal substrate preparation, I shall present recent activities involving other types of materials such as (K,Na)NbO₃ and BiFeO₃ piezoelectrics, for which this technique could prove very useful. Other potential applications of this manufacturing method e.g. pyroelectricity, giant electrostriction, etc. will be discussed.

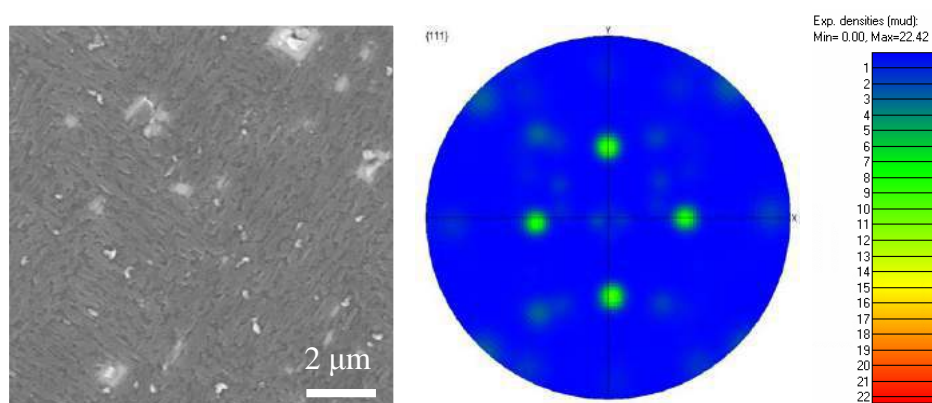

Development and Performance of Zirconia Based Oxygen Transport Membranes for Carbon Capture Processes

Steven Pirou^{*1}, Peter Vang Hendriksen¹, Andreas Kaiser¹, Ragnar Kiebach¹

1: Department of Energy Conversion and Storage, Technical University of Denmark, Risø campus, Frederiksborgvej 399, DK-4000 Roskilde, Denmark

*Corresponding author email: stepir@dtu.dk

Oxygen Transport Membranes (OTMs) can facilitate a more sustainable society by supplying oxygen to combustion processes, leading for example to more efficient Carbon Capture and Storage (CCS) or cement production. OTMs are inorganic, high temperature devices typically formed by dense Mixed Ionic Electronic Conductors (MIECs). The separation mechanism consists of the following steps: on one side of the OTMs molecular oxygen is reduced to oxide ions, which are incorporated into oxygen vacancies of the MIEC and diffused to the other side, where oxide ions are oxidized back to molecular oxygen. The transport of electrons occurs in the opposite direction. Dual-phase membranes are a good option for applications under harsh conditions (e.g. flue gas containing CO₂, SO₂, H₂O) because they consist of a composite of a stable ionic conductor and a stable electronic conductor, which can combine high oxygen flux and chemical stability at the same time.

This work will describe the use and benefits of OTMs for carbon capture processes and present the development and performance of planar zirconia based dual-phase OTMs taking place at the Technical University of Denmark (DTU). Three composite materials based on the ionic conducting phase 10Sc1YSZ ((Y₂O₃)_{0.01}(Sc₂O₃)_{0.10}(ZrO₂)_{0.89}): 10Sc1YSZ-MnCo₂O₄, 10Sc1YSZ-Al_{0.02}Zn_{0.98}O_{1.01} and 10Sc1YSZ-LaCr_{0.85}Cu_{0.10}Ni_{0.05}O_{3-δ} were successfully prepared and characterized as planar dual-phase asymmetric OTMs for direct operation (4-end mode membrane module) in oxy-fuel combustion power plants. Stability tests performed under conditions relevant for oxy-fuel combustion (SO₂, CO₂, H₂O) underlined the excellent stability of the three composites. Among the zirconia-based membranes, the 10Sc1YSZ-MnCo₂O₄ and 10Sc1YSZ-LaCr_{0.85}Cu_{0.10}Ni_{0.05}O_{3-δ} composites developed in this work display the two highest oxygen permeabilities (1.41 mL_N cm⁻² min⁻¹ and 1.11 mL_N cm⁻² min⁻¹ at 950 °C in air/N₂, respectively), which is 200 % higher than the highest oxygen permeation flux previously reported in literature.

Graphene based coatings for corrosion protection

Feng Yu¹, Luca Camilli¹, Adam C. Stoot¹, Ting Wang¹, David M. A. Mackenzie¹, Michele Curioni², Robert Akid², Peter Bøggild^{1*}

1.DTU Nanotech, Technical University of Denmark, Kgs. Lyngby, 2800, Denmark

2.School of Materials, The University of Manchester, Manchester, M13 9PL, UK

*Corresponding author E-mail: Peter.Boggild@nanotech.dtu.dk

Owing to its superior impermeability,¹ graphene shows great potential for application in anticorrosive coatings as a barrier material. Despite the initial success,² graphene has been eventually reported to be ineffective at long-term corrosion protection.³ Intrinsic defects, graphene's high conductivity and weak adhesion on metal surfaces are the main issues that hamper the use of graphene in coating technology. We have recently reported that a multilayer graphene (MLGr) coating grown via chemical vapor deposition (CVD) can effectively slow down the corrosion of Ni-seeded stainless steel (SS) in neutral media under harsh conditions⁴. This result was explained in terms of the long diffusion pathway provided by the MLGr film. Yet, this approach, although effective in long-term protection, has still various limitations. Firstly, many commercially relevant metals and alloys cannot withstand the high temperature required for CVD graphene growth. Moreover, we have reported that the MLGr coating can eventually fail to protect metals from corrosion in a different environment, i.e., acidic media.⁵ As acidic species diffuse through graphene defects, they react with the nickel substrate to produce hydrogen, which is generated and trapped at metal-graphene interface. This gas build-up eventually will delaminate the coating completely from the metal surface due to the weak adhesion of MLGr film on nickel. To address these shortages of anticorrosive coatings based on CVD-grown graphene, we report a polymer-graphene hybrid coating, where single layer graphene (SLGr) sheets are sandwiched between polymer layers. These coatings exhibit outstanding long-term (120 days) protection of commercially relevant aluminum alloys in simulated seawater. Coatings fabricated with graphene layers being sandwiched with polymer layers consistently show much better corrosion performance than graphene-free reference ones. The number of graphene layers is crucial for the corrosion performance of the coating. Results show that polymer-graphene-polymer coating cannot effectively protect aluminum alloy from corrosion after 30 days of immersion, but the coating that consists of 2 graphene sheets in-between three polymer layers can perfectly protect aluminum from corrosion even after 120 days. The graphene-free reference samples, on the other hand, show signs of heavy degradation already after only 30 days of immersion. We also demonstrate that our coatings are effective corrosion barriers even when applied on steel and brass, hence highlighting the flexibility and universality of our approach. We anticipate that this type of polymer-graphene composite could provide a high-performance coating for corrosion protection of various industrially-relevant metals and alloys.

1. Bunch, J. Scott, et al. Nano letters 8.8 (2008): 2458. 2. Chen, Shanshan, et al. ACS nano 5.2 (2011): 1321. 3. Schriver, Maria, et al. ACS nano 7.7 (2013): 5763. 4. Stoot, Adam C., et al. Journal of Power Sources 293 (2015): 846. 5. Yu, Feng, et al. RSC Advances 6.26 (2016): 21497.

Session

M

Poster Presentations

See session details and schedule on
www.sustain.dtu.dk





Overcoming barriers of lead-free piezoceramics

Guttorm Syvertsen-Wiig¹, [Andreas B. Richter](#)^{1*}, Sophie Labonnote-Weber¹

1: Ceramic Powder Technology AS (Cerpotech), Kvenildmyra 6, 7093 Tiller, Norway

*andreas.richter@cerpotech.com

Today, more than 98% of the world market for piezoceramic materials consists of lead-containing materials (PZT). Even though RoHS and REACH regulations are pushing towards a replacement of PZT, the absence of a reliable supply of lead-free materials is an impeding factor during the transition phase. The state-of-the-art process used to produce PZT materials, solid-state synthesis, is not suitable for lead-free piezoceramics, mainly due to evaporation of volatile species and poor sinterability of the powders. Therefore, substantial effort is needed to develop and modify production and processing technologies to qualify lead-free piezoceramic materials and prove their performance and durability on a component level.

Spray pyrolysis is a scalable synthesis route with the capability to produce lead-free piezoceramic materials in excellent quality and in industrial amounts, thereby, overcoming a crucial barrier on the way to the large-scale commercialization of lead-free piezoceramics. The process spray pyrolysis yields homogeneous materials, stoichiometric control and sub-micron particles with excellent sinterability. Recent results from the production and subsequent characterization of lead-free piezoceramic powders will be presented.

Despite the properties and quality offered, component production protocols developed for solid-state powders cannot be directly applied to spray pyrolysed materials. Additionally, lead-free materials offer additional advantages such as the possibility to replace expensive noble-metal electrodes with low-cost nickel. CerPoTech and partners are developing components using spray-pyrolysis powders and employ industrial standard testing methods to verify the performance and consistency of the materials and components. An outlook on the demonstration of the components and the way to develop competitive products will be given.

Life cycle assessment of hydrogen production from water electrolysis

Guangling Zhao*, Allan Schrøder Pedersen, Søren Højgaard Jensen, Christopher R. Graves, Ming Chen, Jens Oluf Jensen, Eva Ravn Nielsen

Department of Energy Conversion and Storage, Technical University of Denmark, Frederiksborgvej 399, 4000 Roskilde Denmark

*Corresponding author Guangling Zhao email: guaz@dtu.dk

Hydrogen produced from renewables, works as an energy carrier and as energy storage medium, also overcome the intermittency of typical renewable energy sources. Three main electrolysis technologies are now dominate hydrogen production, which are alkaline electrolysis, polymer electrolyte membrane (PEM) electrolysis, and solid oxide electrolysis cells (SOEC). The problem is there is no comprehensive environmental performance of these three technologies available with the same system boundary. In this paper, we perform a life cycle assessment for three electrolysis technologies. Two types of material components are chosen to carry on the analysis. Life cycle inventories for all components use in the modules/types for each technology and their associated up- stream and down- stream are modelled.

Flexible, lightweight and paper-like supercapacitors assembled from nitrogen-doped multi-dimensional carbon materials

Xianyi Cao, Jens Øllgaard Duus, Qijin Chi*

DTU Chemistry, Technical University of Denmark, DK-2800 Kongens Lyngby, Denmark.

*Corresponding author. E-mail: cq@kemi.dtu.dk

Flexible supercapacitors have shown great potential to fulfill the increasing demand on wearable, miniature, lightweight, thin and highly efficient power supply systems for advanced portable electronics. Owing to its superior supercapacitive performances as well as high chemical stability and excellent mechanical flexibility, graphene (GR) based flexible supercapacitors have received much research attention in recent years. However, GR-based supercapacitors often suffer from GR restacking leading to capacitance attenuation. Therefore, some macromolecules, polymers and zero-dimensional/one-dimensional (0D/1D) nanomaterials have been tested as spacers to prevent GR sheets (GRSs) from restacking for constructing three-dimensional (3D) porous electrodes. Besides, heteroatom doping of GRSs could further improve their specific capacitance by introducing pseudocapacitive characteristics and increasing hydrophilicity. In this work, a facile approach is developed to prepare nitrogen-doped carbon based flexible and free-standing paper electrodes (N3CPs) built from three types of representative carbon materials in different dimensions (0D: carbon black nanoparticles (CBNPs); 1D: carbon nanotubes (CNTs); 2D: GRSs) with melamine as the nitrogen doping source. The N3CP electrode has demonstrated several advantages, such as enhanced porosity, improved electrical conductivity and high nitrogen doping level. Electrochemical tests have shown that thanks to the synergistic effects of hybrid-dimensional optimized carbon materials, 3D hierarchical porous nanostructure and effective nitrogen doping, a N3CP based flexible supercapacitor has shown the combined advantages of high capacitance, high rate capability and long cycling life (>20,000 cycles). The results hold promising prospects towards practical applications of such flexible supercapacitors in portable electronics.

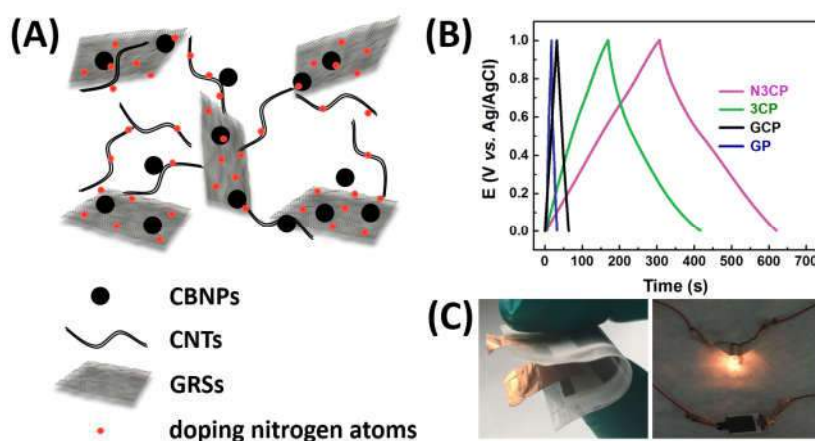

Fig.1 (A) Schematic for the heterostructure of the prepared nitrogen-doped multi-dimensional carbon materials. (B) Charge-discharge curves of different paper electrodes at $1 \text{ A}\cdot\text{g}^{-1}$. (C) A lab-made N3CP based flexible supercapacitor (left) and a miniature bulb is lightened up by such a flexible supercapacitor (right). Not drawn to scale.

Acknowledgments

This work was supported by DFF-FTP, the Danish Research Council for Technology and Product Science (to Q.C., Project No. 12-127447). X.C. is grateful for the support from the Chinese Scholarship Council (PhD scholarship No. 201406170040).

References

[1] Z. Pan, M. Liu, J. Yang, *et al.*, *Adv. Funct. Mater.*, **2017**, 1701122. [2] Y. Wang, J. Chen, J. Cao, *et al.*, *J. Power Sources*, **2014**, 271, 269-277. [3] X. Zhang, P. Yan, R. Zhang, *et al.*, *Int. J. Hydrogen Energy*, **2016**, 41, 6394-6402. [4] Z. D. Huang, B. Zhang, S. W. Oh, *et al.*, *J. Mater. Chem.* **2012**, 22, 3591-3599.

Inorganic ions assisted design and synthesis of all-inorganic halide perovskite nanowires for sustainable solar-energy harvesting

Yingying Tang, Qijin Chi*

DTU Chemistry, Technical University of Denmark, DK-2800 Kongens Lyngby, Denmark.

* Corresponding author email: cq@kemi.dtu.dk

Metal halide perovskites with unique physicochemical properties have emerged to the forefront of light absorber materials, because of their great potential for solar cells, photodetectors, light-emitting devices, field-effect transistors and lasers.^{1,2} Tunable wavelength, large diffusion length, long carrier lifetime, scalable and cost-efficient production are their most striking characteristics. These characters are, however, morphology and size dependent. To date, researchers have successfully engineered perovskites in the forms of nanocubes, nanospheres, and nanoplatelets with sizes controlled from several to hundreds of nanometers. However, the synthesis of perovskite nanowires with controlled morphology is rarely successful. In this communication, we show the feasibility of the controlled synthesis of CsPbCl₃ nanowires via the pretreatment by Cu²⁺ ions.³ The resulting nanowires have a diameter of ca. 20 nm and an average length of 500 nm, with their structures and photoelectrochemical performance systematically studied. These CsPbCl₃ nanowires enabled a 3.5-fold photocurrent enhancement compared to untreated nanocubes. The results clearly suggest that they are a promising photonic material for fabrication of ultraviolet detection devices, as well as our newly developed method could be a generally effective way in controlling morphology and optoelectronic properties of all-inorganic halide perovskite nanostructures.

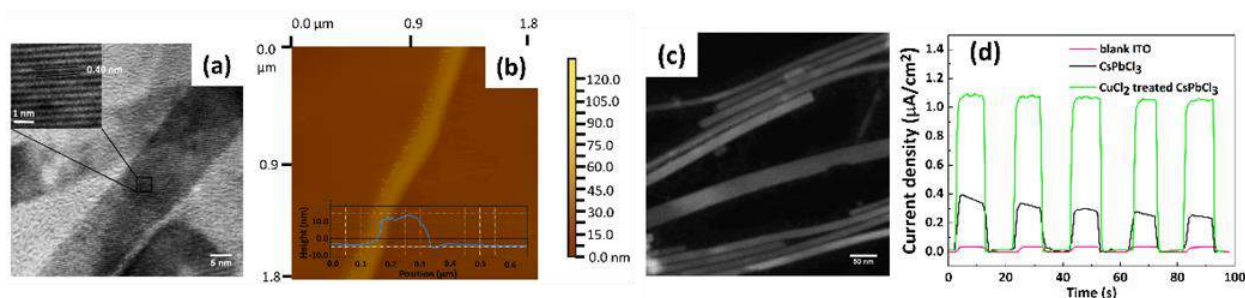

Figure 1. Characterizations of CuCl₂ pretreated CsPbCl₃ nanowires: (a) TEM image, (b) AFM image, (c) STEM image, and (d) comparison of photocurrent responses obtained at various photoelectrodes.

References

- (1) Green, M. A.; Ho-Baillie, A.; Snaith, H. J. *Nature Photon.* **2014**, *8*, 506-514.
- (2) Grätzel, M. *Nature Mater.* **2014**, *13*, 838-842.
- (3) Tang, Y.; Chi, Q. *The manuscript in preparation* **2017**.

Acknowledgement

This work was supported by the Villum Foundation (to Q.C. and Y.T.) and by Independent Research Fund Denmark-Nature Sciences (DFF-FNU, Project No. DFF-7014-00302, to Q.C.). Y.T. is grateful for the Villum Foundation supported postdoc fellowship.

Diffusion of dopants in nanostructured black silicon for application in solar cells

Andreas R. Stilling-Andersen¹, Olga Solodovnikova^{2,*}, Rasmus Schmidt Davidsen³, Beniamino Iandolo⁴

1,2: DTU Nanotech

3,4: DTU Nanotech Postdoc

*Corresponding author email: s163967@student.dtu.dk

Black silicon is a promising material for solar cells as its nanostructured surface can suppress optical reflection in a broad spectral range [1]. This eliminates the need for a conventional antireflective coating, although a passivation layer is still required to minimize surface recombination [2]. Black silicon also has the potential to increase cell efficiency thanks to its superior absorption of light [2][3]. The majority of industrial silicon cells consist of a p-type silicon substrate into which phosphorous is diffused using a liquid POCl_3 source at high temperatures, thus creating the p-n junction [4][5]. Since black silicon has characteristic features in the range of 100-500 nm, diffusion of phosphorous is challenging to characterize with standard methods such as the macroscopic 4-point probe, and therefore to optimize [6]. This is one of the issues that make black silicon difficult to introduce in standard production lines of solar cells. Here, we have investigated the effect of temperature and time during of the doping process (which consists of deposition of a phosphorous-doped glass and a phosphorous drive-in step) on the reflectivity and sheet resistance of black silicon fabricated by reactive ion etch. Our results show that decreasing temperatures and times during the doping process, as compared to values often used on conventionally wet-textured silicon by the industry, provide more suitable values of reflectivity and sheet resistance for device fabrication.

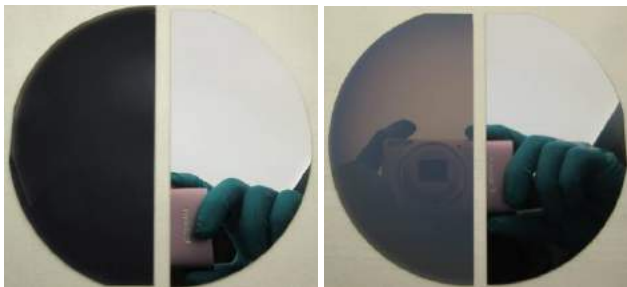

Figure 1: Left shows black silicon and silicon doped at 850°C with a time of 15 min. Right shows black silicon and silicon doped at 1050°C with a time of 30 min. This demonstrates the impact of high temperatures and time on the reflectivity of black silicon.

References:

- [1] Otto, M., & Wehrspohn, R. B. (2015). Black Silicon Photovoltaics. *Advanced Optical Materials*, 2, 147-164.
- [2] Savin, H., Päivikki, R., von Gastrow, G., Ortega, P., Calle, E., Garin, M., & Alcubilla, R. (2015). Black silicon solar cells with interdigitated black-contacts achieve 22.1% efficiency. *Nature Nanotechnology*, 10, 624+.
- [3] Koynov, S., Brandt, M. S., & Stutzmann, M. (2006). Black nonreflecting silicon surfaces for solar cells. *Applied Physics Letters*, 88(20), 203107.
- [4] Li, H., Kim, K., Hallam, B., Hoex, B., Wenham, S., & Abbott, M. (2016). POCl_3 diffusion for industrial Si solar cell emitter formation. *Frontiers in Energy*, 11, 42-51.
- [5] Nauhaus, D.-H., & Münzer, A. (2007). Industrial Silicon Wafer Solar Cells. *Advances in OptoElectronics*, 2007, 24521.
- [6] Plakhotnyuk, M. M., Gaudig, M., Davidsen, R. S., Lindhardt, J. M., Hirsch, J., Lausch, D., . . . Hansen, O. (2017). Low surface damaged drier etch black silicon. *Journal of Applied Physics*, 122(14), 143101.

Technology for Si/CZTS Tandem Solar Cell

A. Hajjafarassar^{1*}, A. Crovetto², T. Pedersen³, S. López Mariño¹, J. Schou⁴, O. Hansen¹

1: DTU Nanotech, Technical University of Denmark, DK-2800 Kgs. Lyngby, Denmark

2: DTU Physics, Technical University of Denmark, DK-2800 Kgs. Lyngby, Denmark

3: DTU Danchip, Technical University of Denmark, DK-2800 Kgs. Lyngby, Denmark

4: DTU Fotonik, Technical University of Denmark, DK-4000 Roskilde, Denmark

*email: alhaj@nanotech.dtu.dk

Photovoltaic (PV) technology, that directly converts the abundant solar photons into electrical energy, has developed into one of the most promising sustainable energy technologies due to continued reductions in costs. Single material solar cells, however, are now as efficient as physical and practical limits allow. To improve efficiency further, tandem (or multi-junction) solar cells with complementary band gaps must be used, since this approach allows efficiency beyond the “detailed balance” limit for single junction solar cells¹ due to reduced thermalization losses².

Silicon-based tandem solar cells have attracted huge attention over the recent years as they can leverage the well-established manufacturing capacity of the existing crystalline silicon technologies. A suitable, i.e., inexpensive, earth abundant, stable and non-toxic, material with an appropriate bandgap to be used as the top cell absorber has, however, yet to be identified. CZTS, a quaternary compound semiconductor based on non-toxic and earth abundant elements ($\text{Cu}_2\text{ZnSnS}_4$), with a band gap of 1.5 eV, is a promising candidate for the upper cell³. However, integrating CZTS with silicon is challenging due to silicon-incompatible processing steps in synthesis of CZTS, such as high temperature (550-600°C) annealing of the metallic precursors in a sulfur atmosphere. This can lead to inter-diffusion of detrimental metallic elements (e.g., Cu) into the bottom silicon cell. Since silicon is sensitive to metallic contamination, this may result in extremely poor performance of the device. Therefore, developing a tunnel/barrier layer between the two absorbers will be a decisive innovation for the construction of such a cell.

Here, we present an initial evaluation of titanium nitride (TiN) as a potential material for the tunnel/barrier layer⁴. Optical simulations using the net-radiation method⁵ were performed on a simplified tandem structure to estimate the optical performance of TiN as the buffer layer. It was established that at most 15-20 nm of TiN can be tolerated before the optical losses due to absorption in TiN is significant. The diffusion barrier properties of TiN deposited with Plasma Enhanced Atomic Layer Deposition (PEALD) were investigated using a simple stack of Si/TiN(25nm)/Cu, which was isothermally annealed in vacuum at 550 °C to simulate the CZTS synthesis conditions. After the annealing, the samples were characterized by X-Ray diffraction (XRD), four point probe measurements, and X-Ray Photoelectron Spectroscopy (XPS) to determine the effectiveness of the TiN diffusion barrier. It was concluded that 25 nm of TiN was not enough to avoid Cu in-diffusion to the Si layer, as revealed by the presence of Copper Silicides (Cu_3Si) from XRD analysis and an increased sheet resistance inherent to these Cu compounds.

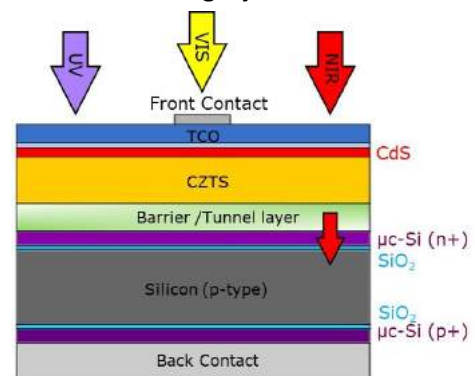

Figure 1: Schematic of the monolithic Si/CZTS tandem structure (not to scale).

1. Shockley, W. & Queisser, J. *Appl. Phys.* **1640**, 510–519 (1960).
2. Green, M. A. & Bremner, S. P. *Nat. Mater.* **16**, 23 (2016).
3. Sun, K. *et al. Adv. Energy Mater.* **6**, 4–9 (2016).
4. Knoops, H. C. M. *et al. J. Electrochem. Soc.* **155**, G287 (2008).
5. Siegel, R. *Sol. Energy* **15**, 273–276 (1973).

Dual phase composites for tubular oxygen transport membranes

Lev Martinez, Astri Bjørnetun Haugen, Wolff-Ragnar Kiebach*

DTU Energy. Technical University of Denmark. DK-4000 Roskilde, Denmark.

woki@dtu.dk

Dual-phase composites based on ionic-conductors (e.g. ceria and zirconia based materials) and electronic conductors (e.g. perovskites) have demonstrated to be suitable materials for oxygen transport membranes (OTM). Chromite perovskites are promising candidates to be used in OTMs, due to their high electronic conductivity, thermo-chemical stability at high temperatures (~ 1000 °C) and in reducing environments ($pO_2 \sim 10^{-20}$ atm). However, their chemical compatibility with ion-conductors in OTMs configuration needs to be further investigated.

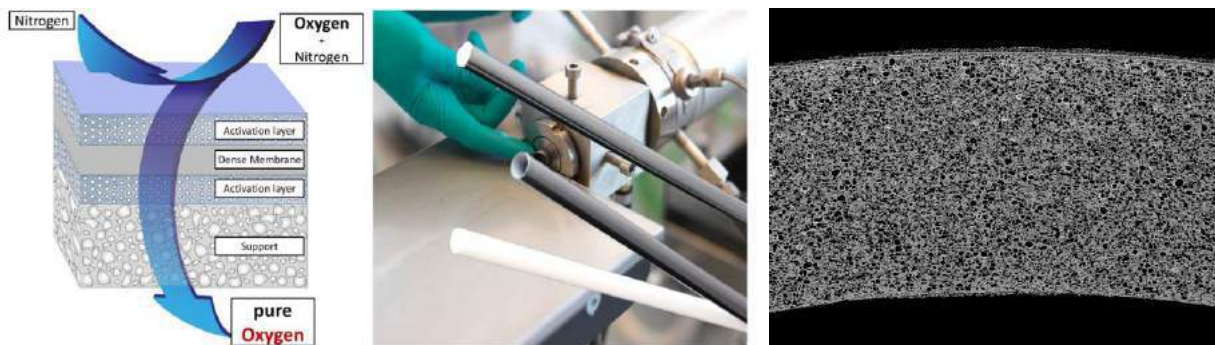

a) Schematic illustration of an oxygen transport membrane. b) Tubular oxygen transport membranes developed at DTU Energy. c) SEM cross section of a tubular oxygen transport membrane.

Composites consisting of 30 vol.% perovskites $LaCr_{0.85}Cu_{0.10}Ni_{0.05}O_{3-\delta}$ (LCCN) and $Y_{0.8}Ca_{0.2}Cr_{0.8}Co_{0.2}O_3$ (YCCC), and 70 vol.% ionic conductors $Zr_{0.802}Sc_{0.180}Y_{0.018}O_{2-\delta}$ (10Sc1YSZ) and $Ce_{0.9}Gd_{0.1}O_{1.95}$ (CGO10) were chosen as materials. Composites were sintered in air at 1300 °C and stability tests in humidified forming gas at 900 °C for 24 hours were carried out. SEM-EDS and XRD analyses were performed and possible explanations of the degradation mechanism were put forward.

In 10Sc1YSZ-containing composites, low densification, decomposition of the perovskites due to mobility and evaporation of transition metals in the B-side, Ca mobility in YCCC, as well as formation of a La/Zr insulating phase in LCCN were found. In contrast, CGO10-based samples showed > 90% of relative density and higher stability towards reducing conditions. Oxygen permeation tests were performed in both, CGO10-YCCC and CGO10-LCCN composites. Oxygen fluxes up to $0.4 \text{ Nml}\cdot\text{cm}^{-2}\cdot\text{min}^{-1}$ ($0.3 \mu\text{mol}\cdot\text{cm}^{-2}\cdot\text{s}^{-1}$) were obtained at 950°C in air/ N_2 gradient when using 1 mm thick pellets. These results indicate that CGO10-based dual-phase composites are promising OTM materials which require further research for improvement.

Literature: [1] Julbe, A. et al. *Catalysis Today*, 104 (2005), 102-113. [2] Den Exter, M. J., et al. *Inorganic Membranes for Energy and Environmental Applications*, 2009, 27-51. [3] Gupta, S. et al. *Materials Science and Engineering*, 90 (2015), 1-36. [4] Suvorov, S.A. et al. *Refractories and Industrial Ceramics*, 45-2 (2004), 94-99. [5] Kawada, et al. *Solid State Ionics*, 50 (1992), 189-196.

Biomaterials reaction to fire

Gabriel-Victor Risco¹, Frank Markert*¹, Anne Christine Steenkær Hastrup²

1: DTU Civil Engineering, Section Building Design, Fire Group

2: Teknologisk Institut, Byggeri og Anlæg, Træ og biomaterialer

*Corresponding author email: fram@byg.dtu.dk

There is a strong demand for alternative sustainable construction materials. The drivers are to apply materials that provide “natural” surfaces, facades and structures. Further, materials with high insulation at low costs and materials improving a healthy indoor climate are of high interest. Therefore, new bio-composite materials are developed to reach these technical and commercial targets. The materials need to fulfill a number of parameters in order to be acceptable on the market as well as being reusable within the philosophy of a circular economy. They need to have a minimum of VOC emissions, good physical mechanical properties and last not least an acceptable classification from the fire safety engineering perspective. In conclusion, the bio-composites are regarded as sustainable materials, but have to regard fire safety requirements to be widely acceptable in construction of sustainable, residential buildings.

In order to fulfill the latter requirements several means are applicable, such as sprinkling and /or passive fire protection systems. Additional, fire resistance of building materials may be improved using flame retardants as boron salts, aluminum hydroxide or ammonium phosphate. These may have adverse effects to the indoor climate or the environment as the salts may be washed out with time, resulting in potential adverse effects to people as well as a decrease in the ability to protect against ignition.



Figure 1

Alternative flame retardant systems for bio-composites are therefore needed. This paper describes how the properties of biomaterials may be improved and may lead to a sustainable fire protection. This is shown in figure 1, on the basis of an investigation of pressed wooden plates. The wood is first separated in the three main components cellulose fibers, hemicellulose and lignin. This allows engineering new bio-composites with containing more of the more flame retardant components, as e.g. lignin. Some first results are shown and the wider perspective of this approach is described.

Lit.: Markert, Shaukat, Hastrup, Residential fire solutions in the building sector, presentation on the Nordic Fire Safety Days 2017, Ålborg University, august 2017

Xing et al. (2013) Functionalized lignin for halogen free flame retardant rigid polyurethane foam: Preparation, thermal stability, fire performance and mechanical properties; *Journal of Polymer Research* 20(9) pp. 1-12

Giant Electrostriction in highly defective oxides: The next generation of electromechanical materials.

Simone Santucci^{1*}, Vincenzo Esposito¹, Nini Pryds¹.

1: Department of Energy Conversion and Storage, Technical University of Denmark, Frederiksborgvej 399, Roskilde 4000, Denmark.

*sisan@dtu.dk

'Smart' materials such as piezoelectric or electrostrictive materials, which change their shape in response to external fields, are deployed in a wide range of sensing and actuating applications, including consumer electronics, robots and automotive systems. For these reasons, Giant Electrostriction effect (Giant-E) in rare earth doped cerium oxide is one of the most fascinating discoveries in materials science in recent years. Scientists at the Weizmann Institute of Science (WIS), partners of this project, reported that thin films of Gd-doped Ceria ($Ce_{1-x}Gd_xO_{2-\delta}$, CGO), exhibit an exceptionally high electrostrictive response even under moderate electric field. At present, the most widely used electrostrictor materials contain lead (Pb) which is highly toxic and restricted by the European RoHS directive. CGO, in other hand, contains no hazardous elements, opening further possibilities to develop environmental friendly devices, also for biomedical applications.

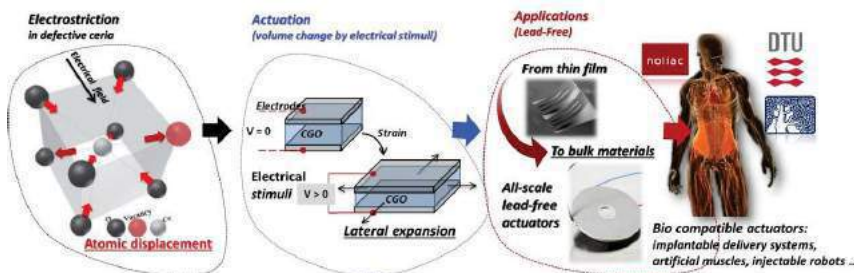

Despite this great potential, so far only CGO thin films with a specific textured microstructure have been found to be electromechanically active. With this in mind, the scientific aim of the GIANT-E project is to unveil the inner mechanism governing the electrostriction effect in these materials, and extend such property to the bulk form. The technological aim is to stabilize the electrostriction effect in thick samples, for a new paradigm of lead-free electromechanical active materials.

Wind power material stocks in a circular economy context

Andrea Corona*¹ Alexandra Bonou², Monia Niero¹, Stig Irving Olsen¹

¹: Division for Quantitative Sustainability Assessment, Department of Management Engineering, Technical University of Denmark, Bygningstorvet, 2800 Lyngby.

²: BoBa I/S, bobagroup.dk

*Corresponding author email: corona@dtu.dk

Decarbonisation of electrical grids and transitioning to renewables abate climate change i.e. compared to fossil sources, wind energy technologies emit 100 times less GHGs during their life cycle. However, uncertainty related to the end of life treatment of components and the issue of safe supply of resources for the infrastructure of renewables call for attention. In a circular economy context materials stocks embodied in wind power plants are resources for the future. For some materials such as steel, aluminium and copper, recycling technologies are already available and determined by collection and recovery. For other stocks such as composites the challenge is higher given the lack of cost effective recycling technologies and of secondary markets.

Seeing these end of life (EoL) treatment options from a life cycle perspective it should be an environmental benefit to recycle. To exemplify, Figure 1 presents the current market options for the EoL treatment of wind power plant components. A Life Cycle Assessment (LCA) reveals the benefits from metal recycling are high given the assumed recovery rates and the lower energy requirements compared to primary production. Contrary, the current treatment options for the blades which involves shredding and use of the material in cement production is suboptimal since the burdens from treatment offsets the benefits from avoided production. The case of the blades is particularly interesting since the properties of the blade material are

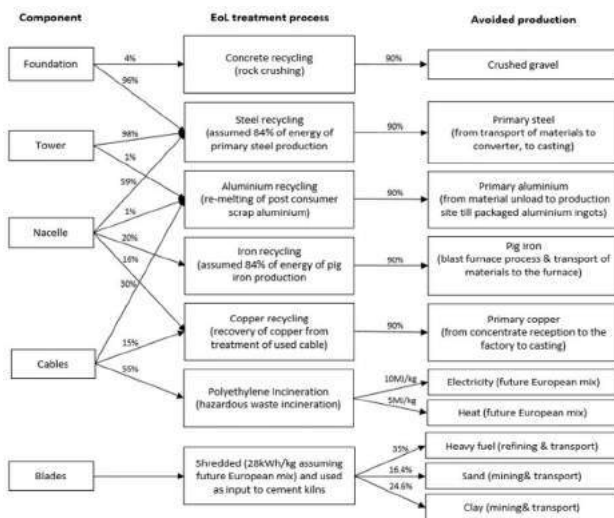

Figure 1. EoL current treatment options for wind power plant components

different those of the glass fibre, epoxy and wood that compose it. The material recovered after the recycling also has different properties and its potential use needs to be understood. Despite the high research focus there are as yet no economically viable recycling technologies particularly for glass fibre composite materials. Alternative mechanical, thermal and chemical treatment options leading to the production of powdered fillers and other fibrous products are suggested. An additional challenge with blade EoL management is related to the geometric particularity of the structure; blades can be more than 75 m long, covering an area of approximately 500 m². On a conceptual level and beyond mere technology-fixes, manufacturers and product developers need a mindset-shift i.e. to develop technologies and products that are designed and manufactured in a way that can be recovered and reused in multiple loops.

Self-Reinforced PLA Composites: Bio-based and Biodegradable Polymer Materials for Industrial Applications

Giacomo Schillani, Bo Madsen, Justine Beauson*

Composites and Materials Mechanics, DTU Wind Energy, Denmark

*Corresponding author: jube@dtu.dk

Since their introduction, plastic materials have changed completely our lifestyle, and nowadays the contemporary society strongly relies on these materials. The utilization of plastic materials must however be considered in relation to their environmental impact. Plastic feedstocks are directly related to petroleum resources, and after their use, plastic products end their life in landfills or they are burned in incinerators. The need in society for separation from petroleum resources, and the concern about waste disposal issues and global climate changes, have forced industry to start thinking about new solutions. A possible solution is represented by bio-based and biodegradable polymer materials. One of the most promising bio-based polymer is poly-lactic acid (PLA). PLA presents, however, two drawbacks that have limited its use in the industry: its relative low maximum utilization temperature, and its relative large brittleness. It is possible to resolve both these drawbacks through the design of so-called self-reinforced PLA composites, which are composites with PLA reinforcement fibers in a PLA matrix. Self-reinforced PLA composites are currently being investigated in the Bio4Self project, a Horizon 2020 project funded by the European Commission.

Self-reinforced polymer composites are composites where the reinforcement fibers and matrix are made by the same polymer (or by polymers belonging to the same family); this characteristic brings many advantages, such as the possibility to create perfect interfaces between fibers and matrix, and easy recycling of products via re-melting. The better properties of the reinforcement fibers are achieved through an alignment of the polymer chain molecular structure, which however must not be affected during composite processing, where fibers and matrix are heated up to melt the matrix.

A MSc student project within Bio4Self deals with processing and characterization of self-reinforced PLA composites. The mechanical properties of the PLA fibers are characterized and analyzed, and the processing of the composites is studied by investigating the effect on the mechanical properties of the composites.

Lead-free, textured piezoelectric ceramics

Astri Bjørnetun Haugen,^{1*} Erling Ringgaard² and Franck Levassort³

¹Department of Energy Conversion and Storage, Technical University of Denmark, Frederiksborgvej 399, 4000 Roskilde, Denmark

²MEGGITT Sensing Systems, Porthusvej 4, 3490 Kvistgaard, Denmark

³GREMAN UMR 7347 CNRS, François-Rabelais University, 26 Rue Pierre et Marie Curie, 37100 Tours, France

*Corresponding author email: ahua@dtu.dk

Piezoelectric ceramics are key materials in many applications, such as actuators for fuel injection, sensors for flow monitoring, and transducers for medical imaging. However, the vast majority of the materials are based on lead oxides such as (Pb,Zr)TiO₃, and more sustainable, lead-free replacement materials are sought after. The biocompatible K_{0.5}Na_{0.5}NbO₃ (KNN) is therefore being explored, for example for use in high-frequency ultrasound. Ultrasound above >20 MHz is rapidly becoming an established clinical tool for the high-resolution imaging of blood vessels and many other superficial structures requiring low penetration depth, such as skin tumors, exterior segments of the eye and small animals.^{1,2} The transducer is mainly composed of a piezoelectric material that generates ultrasound. At present, active layers are nearly always lead-based, they do however have a high specific gravity and acoustic impedance (~35 MRayl), and are incompatible with future legislations.³ Recently, Huo and colleagues reported an ultrahigh electromechanical coupling factor ($k_{33} \sim 95\%$) in a single crystal of KNN doped with Li, Ta and Mn.⁴ Single crystals provide high properties, but are expensive and challenging to fabricate. Textured ceramics (ceramics with crystallographically aligned grains) can therefore be a good solution.⁵ In this work, we are exploring textured lead-free piezoelectrics for high-frequency ultrasound transducers, based on the high- k_{33} composition of KNN doped with Li, Ta and Mn. The first results on synthesis of textured ceramics will be presented.

¹ Y. Chen, W.B. Qiu, K.H. Lam, B.Q. Liu, X.P. Jiang, H.R. Zheng, H.S. Luo, H.L.W. Chan, *et al.*, *Ultrasonics*, **56** 227–31 (2015).

² K.K. Shung, J.M. Cannata, and Q.F. Zhou, *J. Electroceramics*, **19** 139–145 (2007)

³ European Parliament and The Council Of The European Union, *Off. J. Eur. Union*, **13** 1–24 (2003)

⁴ X. Huo, R. Zhang, L. Zheng, S. Zhang, R. Wang, J. Wang, S. Sang, B. Yang, *et al.*, “(K, Na, Li)(Nb, Ta)O₃:Mn Lead-Free Single Crystal with High Piezoelectric Properties,” *J. Am. Ceram. Soc.*, **98** [6] 1829–1835 (2015).

⁵ A.B. Haugen, G.H. Olsen, F. Madaro, M.I. Morozov, G. Tutuncu, J.L. Jones, T. Grande, and M.-A. Einarsrud, *J. Am. Ceram. Soc.*, **97** [12] 3818–3825 (2014)

Session

P

Oral Presentations

See session details and schedule on
www.sustain.dtu.dk



Digital resonant laser printing: manipulating optical meta-elements on demand

Xiaolong Zhu^{1*}, Mehdi Keshavarz Hedayati¹, Søren Raza¹, Uriel Levy², N Asger Mortensen³, Anders Kristensen¹

1: DTU Nanotech, Technical University of Denmark. 2: Department of Applied Physics, The Hebrew University of Jerusalem. 3: Center for Nano Optics & Danish Institute for Advanced Study, University of Southern Denmark.

*Corresponding author email: xizhu@nanotech.dtu.dk

Realized by micro and nanofabrication technologies, nanophotonics has offered the control of light with nanoscale metallic or dielectric elements. One popular demonstration is optical metasurfaces, which rely on the ability to precisely control its individual meta-elements on the optical surfaces. By spatial control over light, metasurfaces allow for engineering scattering spectra as well as the optical wave-fronts of the output light sheet.

We developed a digital resonant laser printing (DRLP) technique as a flexible post-writing technology for mass-customization of optical metasurfaces. Strong on-resonance energy absorption under pulsed laser irradiation locally elevates the lattice temperature of individual meta-atoms in an ultra-short time scale. This was demonstrated for both metallic [1], and high-index dielectric metasurfaces [2]. In the DRLP process, rapid melting allows for surface-energy-driven morphology changes and sintering/annealing of individual meta-elements with associated modification of amplitude, phase and polarization of the reflected and transmitted light from the metasurface. By controlling of the DRLP process, we can manipulate the meta-elements on demand and with a very high precision. Combined with the use of pre-fabricated large-area metasurface templates, DRLP is a promising approach for next-generation low-cost optical devices for advanced applications.

[1] X. Zhu, C. Vannahme, E. Højlund-Nielsen, N.A. Mortensen, A. Kristensen Plasmonic colour laser printing, *Nat. Nanotechnol.*, 11 (4) (2016), pp. 325-329, 10.1038/nnano.2015.285.

[2] X. Zhu, W. Yan, U. Levy, N.A. Mortensen, A. Kristensen Resonant-laser-printing of structural colors on high-index dielectric metasurfaces, *Sci. Adv.*, 3 (5) (2017), p. e1602487, 10.1126/sciadv.1602487.



If bio-based plastics is the answer, what was the question?

Michael Z. Hauschild^{1*}

1: DTU Management Engineering

*Corresponding author email: mzha@dtu.dk

In the decarbonization of our society, biological feedstocks are promoted for the production of chemicals and materials, notably polymers, in a future sustainable society, and new polymer materials are developed based on monomers based on extracts from biological feedstocks or obtained from fermentation processes (e.g. lactic acid used for PLA). An ambition is thus to make fossil resources superfluous and avoid the CO₂ emission that is associated with their use, if not before at the end of life of the chemical or polymer.

But is the use of bio-based plastics really better for the climate? In order to answer this question, we need to look into the life cycle of the material in its various applications and compare it to the current situation with fossil-based plastics – from the sourcing of resources over production and use to end of life.

Another reason to favor bio-based polymer materials is the issue of plastic waste accumulating in the environment and increasingly exposing ecosystems and humans due to the persistence in the environment. Biodegradable polymers would help avoiding this problem, but is bio-based the same as bio-degradable, and does bio-degradable mean degradable in the environment? The presentation will answer these questions and discuss the relevance of biodegradability of polymer materials in a future circular economy. Strengths and weaknesses of biobased polymer materials relative to their conventional competitors will be highlighted, and the potential of biobased materials to help tackle the challenges that we are facing in terms of climate change and environmental accumulation of plastic waste will be discussed.

Thin film organic materials: from nanoscale to smart windows.

Francesco Pastorelli francesco.pastorelli.work@gmail.com

Light and organic materials work together in many real life applications, from organic photovoltaics (OPV) to electrochromic windows. In our studies we play with light from the nano scale by using nano-gap antennas [1], to submicron scale by using optical cavities [2,3] and finally, to a macroscopic scale by implementing a standalone electrochromic window that can shade the light powered by and OPV stripe driven by an innovative organic transistor [4,5].

As first design, we implemented a self-assembled nano-gap antenna. The nano-gap antennas are linked at a controlled distance of a few nanometers by Dithiothreitol molecules (self-assembly method). The spacing molecules ensure a minimum distance that plays a fundamental role in the formation of intensity hot spots in the nanogap as well as large and red-shifted scattering peaks. This OPV device, realized in ambient air condition, exhibited an efficiency 14% higher than the reference one showing a relevant enhancement in the red part of the external quantum efficiency measurements. [1]

As second design, we build up a photonic crystal and a metal cavity around a transparent OPV. We enclosed the active material in between two metal electrodes forming an optical cavity designed to optimize photon trapping inside the solar cell. To increase near IR light trapping, while maintaining transparency in the visible, an anti-reflection coating was deposited on top of the front metal contact while a non-periodic multi-layer was inserted in between the back metal contact and the substrate. The cavity configuration was designed specifically for the cell architecture used and we achieved semi-transparent cells with 5.3% PCE, corresponding to 90% the PCE of the opaque cell. [2,3]

Finally, we implement a smart electrochromic plastic window using a flexible organic power transistors prepared with roll-to-roll compatible printing techniques. This innovative transistor is able to drive large currents while handling the thermal aspects in operation together with other organic printed electronics technologies such as large area OPV and large area electrochromic displays. We find especially that an elevated operational temperature is beneficial with respect to both transconductance and on/off ratio. We achieve high currents of up to 45 mA at a temperature of 80 °C with an on/off ratio of 100 which is sufficient to drive large area organic electronics. [4,5]

[1] F. Pastorelli, S. Bidault, J. Martorell and N. Bonod, "Self-assembled plasmonic oligomers for organic photovoltaics", *Advanced Optical Materials*, DOI: 10.1002/adom.201300363, 2014.

[2] F. Pastorelli, P. Romero Gomez, R. Betancur, A. Martinez-Otero, N. Bonod and J. Martorell, "Enhanced Light Harvesting in Semitransparent Organic Solar Cells Using an Optical Cavity Configuration" *Advanced Energy Materials*, DOI: 10.1002/aenm.201400614, 2015.

[3] Francesco Pastorelli, illustration, DOI: 10.1002/aenm.201570008, 2015.

[4] F. Pastorelli, T. M. Schmidt, M. Hösel, R. R. Søndergaard, M. Jørgensen and F. C. Krebs, "The Organic Power Transistor: Roll-to-Roll Manufacture, Thermal Behavior, and Power Handling When Driving Printed Electronics", *Advanced Engineering Materials*, DOI: 10.1002/adem.201500348, 2016.

[5] F. Pastorelli, N. Accanto, M. Jørgensen, N. Van Hulst, F. C. Krebs, "In situ electrical and thermal monitoring of printed electronics by two-photon mapping", *Nature Scientific Report*, DOI:10.1038/s41598-017-03891-7, 2017.



What type of shopping bag to use? Perspectives on the functionality and recycling of polymers

Anders Damgaard^{1*}, Valentina Bisinella¹

1: DTU Environment,

*Corresponding author email: adam@env.dtu.dk

When standing at the super market line and realising you have forgotten to bring a shopping bag the question often arise on which bag to choose? Here the consumer have to pick between a number of different bags made of paper, plastic or other organic materials (cotton, jute, etc.). This bring some users to ask which bag is the most environmentally friendly to choose?

This question is currently being addressed at DTU Environment. Often people would think that the “natural” materials are better than plastic, as it is created from renewable feedstocks, but is this really the case. In the study we consider both the production costs, but do also look into aspects such as the functionality of the bag (durability, volume weight capacity), the potential for recycling, and the other different disposal pathways.

In the study we have looked at a number of different plastic bags currently on the market, which are:

- low-density polyethylene (LDPE)
- recycled polyethylene terephthalate (PET)
- biodegradable carrier bag made of a starch-polyester (biopolymer blend)
- a more durable bag, often with stiffening inserts made from non-woven polypropylene (PP)
- a more durable bag, often with stiffening inserts made from woven polypropylene (PP)
- cotton bag
- paper bag

These types of carrier bags are each designed for a different number of uses. Those intended to last longer need more resources in their production and are therefore likely to produce greater environmental impacts if compared on a bag to bag basis. To make the comparison fair it is therefore necessary to consider the impacts from the number of bags required to fulfil the functional need for the consumer.

The results show that production methods and disposal options, often plays as large a role, as the material type used in the production of the bag. The reason for this is that recycling options and durability is closely linked to these aspects. For the user this means that they also need to think about how they want to use the bag, and not only what seems to be the best option.

Session

P

Poster Presentations

See session details and schedule on
www.sustain.dtu.dk



The future of the packaging industry: Roll-to-roll production of lotus leaves and rose petals

Nastasia Okulova^{*1,2}, Rafael Taboryski¹

1: DTU Nanotech, Ørsteds Plads 344, 2800 Kgs. Lyngby

2: Danapak Flexibles A/S, Strudsbergvej 3, 4200 Slagelse

*Corresponding author email: nao@danapakflex.com

Nowadays most of the consumer products are packed into individual plastic bags and wrapped into plastic foils. Plastic packaging serves primarily as barriers for sunlight, oxygen, water, etc., which prolongs the shelf life of the food and pharmaceutical compounds, and therefore is not always possible to avoid. However it is possible to recycle polymers, with one important note: the packaging needs to be clean and freed of the food residues before it can be recycled. By wasting water and chemicals on cleaning the used plastic foils/bottles/containers, the whole recycling process becomes unsustainable.

The food residue problem can be avoided if the packaging foil does not stick to the packed product. Conventional packaging foils are produced using a roll-to-roll process and it is most convenient to structure the surface of the polymer while producing the foil. In this study hydrophobic structures (mimicking lotus flower and rose petal) are produced at a high speed roll-to-roll process. The replication fidelity is estimated and hydrophobicity of the different surface structures is characterized.

This high-speed and low cost method looks very promising^{1,2}, however further material, structure and droplet analysis should be carried out in order to achieve omniphobicity.

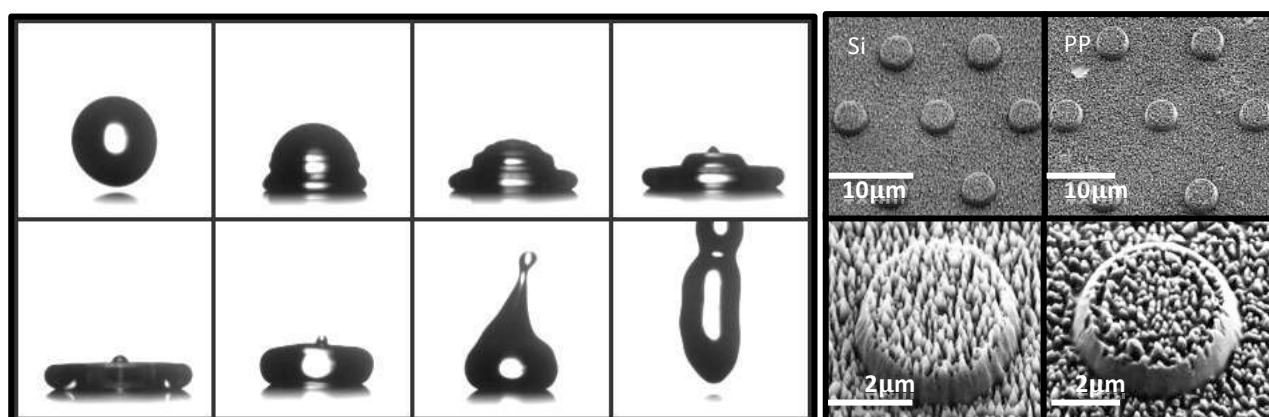

Figure 1. To the left: a water droplet landing on the packaging foil structured with hydrophobic structures. To the right: The original Si structure and the same structure replicated in PP. The PP surface is covered with 10nm Au, hence the sharp needle-like structures appear rounded-off at the top, even though the structures in PP are replicated 100%.

¹ A. Telecka, S. Murthy, L. Schneider, H. Pranov, Taboryski, ACS Macro Lett. 5 (2016) 1034–1038.

² N. Okulova, P. Johansen, L. Christensen, R. Taboryski, MEE 176 (2017) 54-57.

Life Cycle Assessment of Fiber-Reinforced Additive Manufacturing for Injection Molding Insert Production

Thomas Hofstätter*¹, Philippe M Stotz², Niki Bey², David B Pedersen¹, Guido Tosello¹, Hans N Hansen¹

1: Technical University of Denmark, Department of Mechanical Engineering

2: Technical University of Denmark, Department of Management Engineering

*Corresponding author email: thohofs@mek.dtu.dk

Additively manufactured (AM) injection molding (IM) inserts have proved to be capable to substitute conventionally manufactured metal inserts with polymer-based insert enforced with short, virgin, unseized carbon fibers (CFs). It has been shown that the implementation of AM technology resulted in significant improvements when investigating costs and cycle time for smaller part series. However, being a novel technology, AM inserts yield undesired characteristics, e.g. in terms of potential environmental impact because of the lower lifetime compared to metal inserts. Based on physical performance tests, this contribution provides a comparison of environmental performance of conventionally vs. additively manufactured inserts in a full life cycle perspective indicated in Figure 1, including materials, production, use and end-of-life (EoL) stages.

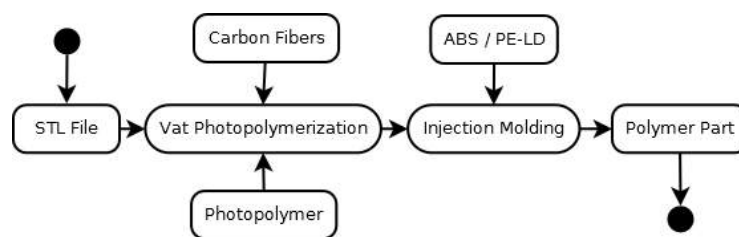

Figure 1 Overall process cycle with inputs and outputs.

The results indicate that the environmental impact of the AM inserts primarily depends on the AM process rather than the production of the photopolymer. As the AM insert is incinerated during the EoL, it does not receive the same credit as the metal insert, which is fully recycled. At low shot numbers (2500 approx.), the metal inserts show a higher impact in some categories (human toxicity non-cancer, freshwater ecotoxicity), but lose out on the global warming potential and human toxicity (cancer). At higher shot numbers, where multiple AM inserts are required to fulfil the function, it is outperformed by the metal insert in every impact category. In a holistic approach, AM can be expected to be preferable in terms of time, cost, and flexibility.

References

- T. Hofstätter, N. Bey, M. Mischkot, A. Lunzer, D. B. Pedersen, and H. N. Hansen. "Comparison of conventional Injection Mould Inserts to Additively Manufactured Inserts using Life Cycle Assessments". In: *Proceedings of Euspen's 16th International Conference & Exhibition*. EUSPEN—European Society for Precision Engineering and Nanotechnology. 2016
- T. Hofstätter, M. Mischkot, D. B. Pedersen, G. Tosello, and H. N. Hansen. "Evolution of Surface Texture and Cracks During Injection Molding of Fiber-Reinforced, Additively-Manufactured, Injection Molding Inserts". In: *Proceedings of ASPE Summer Topical Meeting 2016*. ASPE—The American Society for Precision Engineering. 2016
- T. Hofstätter, N. Bey, M. Mischkot, P. M. Stotz, D. B. Pedersen, G. Tosello, and H. N. Hansen. "Integration of Fiber-Reinforced Polymers in a Life Cycle Assessment of Injection Molding Process Chains with Additive Manufacturing". In: *International Conference on Additive Manufacturing in Products and Applications*. Springer. 2017, pp. 287–295

Session

R

Oral Presentations

See session details and schedule on
www.sustain.dtu.dk





Quantification of methane emission from biogas plants.

Torben Kvist^{1*}, [Nabin Aryal](#)^{1,2**}

*¹Danish Gas Technology Centre, Dr. Neergaards Vej 5B, DK-2970, Horsholm Denmark, tkv@dgc.dk

**²Biological and Chemical Engineering, Aarhus University, Hångvej 2, DK-8200 Aarhus N, Denmark nba@dgc.dk

Abstract

The global energy demand is rapidly growing and approaching to supply from renewable energy sources to minimize the greenhouse gas (GHG) emissions. In this context, biogas production from wastes is a good option to harvest the methane. Biogas technology is a versatile renewable energy source, where different feedstock such as sludge from wastewater treatment facilities, agriculture residue can be used in various sizes to recover methane (Teixeira Franco et al., 2016). Nevertheless, methane losses from biogas plant are one of a key issue need to solve for an economic and environmental benefit (Daelman et al., 2012). So far, precise determination of emission and standard method is not available even though fugitive emission of vapours generating from leaks, diffuse emissions from surfaces and portable flame ionization detector were applied in few studies (Bald et al., 2016; Khoiyangbam et al., 2004). Here, we developed a novel method based on remote sensing and point measuring techniques. Open Path systems (FTIR or laser) device was used for detection of emission. The loss from the individual leakages from biogas plant varied and up to 10% methane losses was detected. Thus, this method is simple, cost-effective and easy to handle by semi-skilled biogas technician on site, which also gives a prospective to control methane emission from biogas plant. Hence, the findings and method applied in this research is useful for wider range of scientific audience working on water development, in particular energy recovery from wastewater treatment plant and development of sustainable solution for economic operation of biogas plant by saving methane loss.

Reference

- Bald, H., VanderZaag, A.C., Burt, S.D., Wagner-Riddle, C., Crolla, A., Desjardins, R.L., MacDonald, D.J., 2016. Methane emissions from digestate at an agricultural biogas plant. *Bioresour. Technol.* 216, 914–922. doi:10.1016/j.biortech.2016.06.031
- Daelman, M.R.J., van Voorthuizen, E.M., van Dongen, U.G.J.M., Volcke, E.I.P., van Loosdrecht, M.C.M., 2012. Methane emission during municipal wastewater treatment. *Water Res.* 46, 3657–3670. doi:10.1016/j.watres.2012.04.024
- Khoiyangbam, R.S., Kumar, S., Jain, M.C., Gupta, N., Kumar, A., Kumar, V., 2004. Methane emission from fixed dome biogas plants in hilly and plain regions of northern India. *Bioresour. Technol.* 95, 35–39. doi:10.1016/j.biortech.2004.02.009
- Teixeira Franco, R., Buffière, P., Bayard, R., 2016. Ensiling for biogas production: Critical parameters. A review. *Biomass and Bioenergy* 94, 94–104. doi:10.1016/j.biombioe.2016.08.014

Bioelectricity production and microbial communities in microbial fuel cell powered by macroalgal biomass

Nannan Zhao¹, Yinan Jiang², Merlin Alvarado-Morales², Laura Treu², Irimi Angelidaki², Yifeng Zhang^{*3}

1: Department of Environmental Engineering, Technical University of Denmark, DK-2800 Lyngby, Denmark

*Email address: yifz@env.dtu.dk

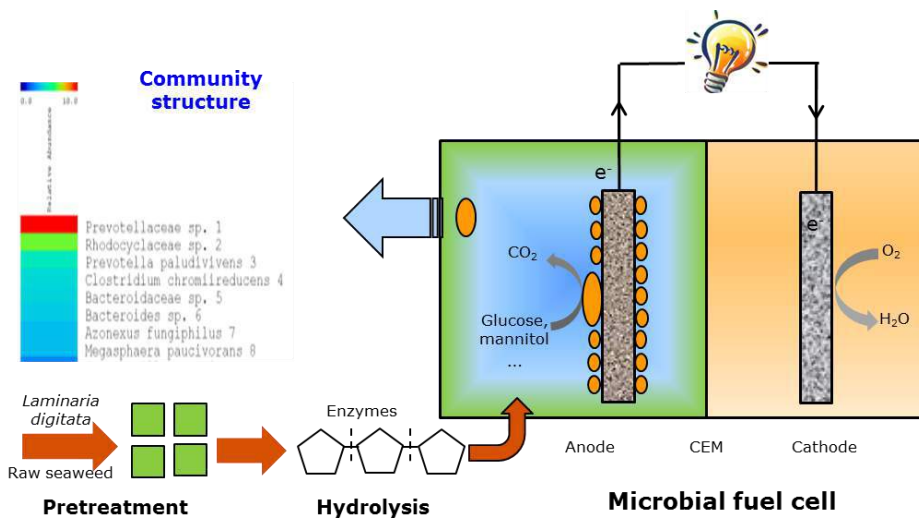

The potential of macroalgae *Laminaria digitata* as substrate for bioelectricity production was examined in a microbial fuel cell (MFC). A stable voltage of 0.6 V (at 1000 ohm) was achieved without any lag time due to the high concentration of glucose and mannitol in the hydrolysate, and it lasted for over 35 days. Total TCOD removal efficiency remained high and reached over 95% at the end of the test. However, the coulombic efficiency was low approx. 12%. The volatile fatty acids analysis implied that glucose and mannitol were degraded through isobutyrate as intermediate. During the operation, pH in anode and cathode exhibited reverse variation because of the proton accumulation in anode. The 16S rRNA gene high throughput sequencing analysis of anodic biofilm revealed complex microbial composition dominated by *Bacteroidetes* (39.4%), *Firmicutes* (20.1%), *Proteobacteria* (11.5%), *Euryarchaeota* (3.1%), *Deferribacteres* (1.3%), *Spirochaetes* (1.0%), *Chloroflexi* (0.7%), *Actinobacteria* (0.5%), and others (22.4%). The predominance of *Bacteroidetes*, *Firmicutes* and *Proteobacteria* demonstrated their importance for substrate degradation and simultaneous power generation. These results demonstrate that macroalgal hydrolysate can be used as a renewable carbon source of microbial electrochemical systems for various environmental applications.

DD-DeCaF: Data-Driven Design of Cell Factories and Communities

Moritz Beber¹, Danny Dannaher¹, Matyas Fodor², Svetlana Galkina¹, Henning Redestig¹, Nikolaus Sonnenschein¹, Markus J. Herrgård*¹ and DD-DeCaF Partners

1: The Novo Nordisk Foundation Center for Biosustainability, DTU

2: Genialis, Inc

*herrgard@biosustain.dtu.dk

Omics data is not leveraged effectively in the biotechnology industry due to lack of tools to rapidly access public and private data and to design genetic and experimental manipulations based on the data. With the rapid development of synthetic biology methods such as the CRISPR/Cas9 system for genome editing, there is an ever increasing need to design complex non-intuitive manipulations involving simultaneous changes at multiple loci. With this project we aim to make a broad spectrum of omics data useful to the biotechnology industry by integrating data analysis with design within the same platform. This platform can be used in a wide range of application areas, ranging from industrial biotechnology to agriculture and human health.

A group of five renowned academic partners (DTU, Chalmers, EMBL, EPFL and UMinho) will drive research on integrative model-based omics data analysis to enable:

1. Metagenomics-enabled design of novel enzymes and biochemical pathways.
2. Omics data-driven design of cell factories for the production of chemicals and proteins.
3. Analysis and design of microbial communities relevant to human health, industrial biotechnology and agriculture.

All research efforts will be integrated in an interactive web-based platform that will be available for the industrial and academic research and development communities, in particular enhancing the competitiveness of biotech SMEs by economizing resources and reducing time-to-market within their respective focus areas. The platform will be composed of standardized and interoperable components that will be freely available for use by academic users.

Additional information: dd-decaf.eu

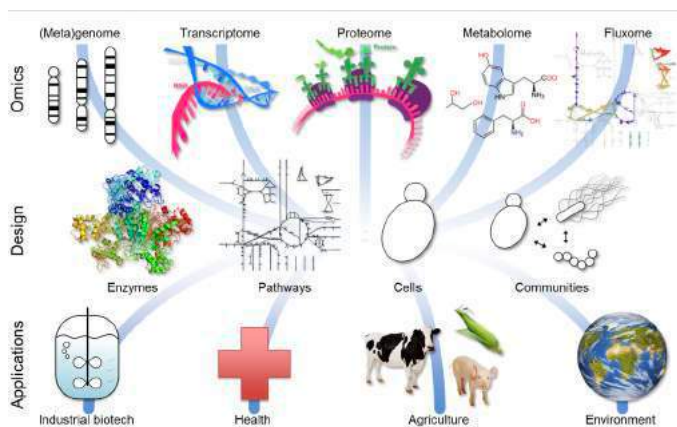

Microbial community dynamics during a successful acclimation process to extremely high ammonia levels in continuous anaerobic digester

Hailin Tian¹, Ioannis A. Fotidis^{*1}, Enrico Mancini¹, Irimi Angelidaki¹

1: Department of Environmental Engineering, Technical University of Denmark, Bygningstorvet Bygning 115, DK-2800 Kgs. Lyngby, Denmark

*Corresponding author email: ioanf@env.dtu.dk

High ammonia concentrations ($> 3 \text{ g NH}_4^+ \text{-N L}^{-1}$), released during anaerobic digestion (AD) of nitrogen-rich substrates, could result in reactor performance instability or even failure (Yenigün & Demirel, 2013). Acclimatized anaerobic communities to high ammonia levels can offer a solution to this problem. Thus, investigation of microbial community dynamics during the acclimation process and characterization of the ammonia-tolerant consortia, can both provide fundamental insight and offer practical engineering solutions to this challenge in the future (Appels et al., 2011). Therefore, in this study, 16S rRNA sequencing was applied to explore the community changes during a successful acclimation process in a mesophilic continuous reactor with a stepwise total ammonia increase ($0.5 \text{ g NH}_4^+ \text{-N L}^{-1}$ each step) up to $10 \text{ g NH}_4^+ \text{-N L}^{-1}$.

Throughout the experimental period, the reactor performance (i.e. methane production, VFA and pH) was stable and within the optimal range of normal anaerobic digestion. 16S rRNA sequencing results showed that a clear microbiome change happened during this process, resulting in narrowed microbial community adapted to high ammonia toxicity. Furthermore, compared to low ammonia levels, *Clostridium ultunense* (syntrophic acetate oxidizing bacteria) and *Methanoculleus spp.* increased significantly in abundance at ammonia levels above $7 \text{ g NH}_4^+ \text{-N L}^{-1}$, indicating an enhanced hydrogenotrophic methanogenic pathway. Interestingly, the most abundant methanogens at the highest ammonia levels were the well-known aceticlastic methanogens- *Methanosarcina spp.*, with more than 60% of the archaea abundance. Overall, the results demonstrated that by evolving to a specialized community composition, anaerobic digestion could happen under extremely high ammonia levels.

Reference:

- Appels, L., Lauwers, J., Degrève, J., Helsen, L., Lievens, B., Willems, K., Van Impe, J., Dewil, R. 2011. Anaerobic digestion in global bio-energy production: Potential and research challenges. *Renewable and Sustainable Energy Reviews*, **15**(9), 4295-4301.
- Yenigün, O., Demirel, B. 2013. Ammonia inhibition in anaerobic digestion: A review. *Process Biochemistry*, **48**(5-6), 901-911.

This work was supported by Energinet.dk under the project framework ForskEL "MicrobStopNH3-Innovative bioaugmentation strategies to tackle ammonia inhibition in anaerobic digestion process" (program no. 2015-12327).

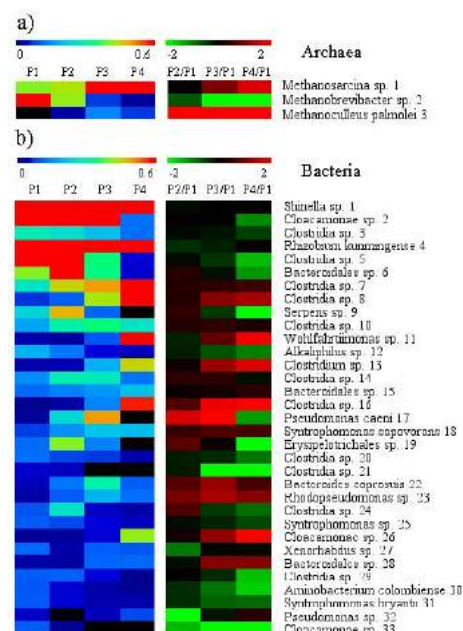

Fig. 1. Relative abundance (%) (left) and the corresponding folds change (right) for the interesting a) archaea and b) bacteria.

Session

R

Poster Presentations

See session details and schedule on
www.sustain.dtu.dk



Early stage Life Cycle Assessment of different Green Biorefinery configurations: assessing the utilization of the press-pulp

Andrea Corona*¹, Morten Birkved¹,

¹: Division for Quantitative Sustainability Assessment, Department of Management Engineering, Technical University of Denmark, Bygningstorvet, 2800 Lyngby.

*Corresponding author email: corona@dtu.dk

The Green biorefinery (GBR) is a new biorefinery technology to convert fresh biomass into fuel, feed and chemicals. The GBR fractionates the biomass into two fractions: a liquid fraction, i.e. the press-juice and a solid fraction, i.e. the press-pulp. A protein-rich feed is produced from the press-juice, while different downstream process has been proposed for the upgrade of the press-pulp (Kromus et al., 2006).

This study evaluates the environmental performance of different upgrade strategies for the press-pulps by using Life Cycle Assessment (LCA) at an early stage of the design process. The studied press-pulp utilization scenarios are: ensiling and utilization as energy-feed for ruminants; drying and utilization as a thermal insulation panel; utilization as a fermentation feedstock for lysine production. The system boundaries go from cradle to the biorefinery gate. Furthermore, they are also expanded to include the credits connected to the substitution of conventional products by the GBR products. The functional unit of the study is: "production and conversion in the GBR of 1ton_{DM} of biomass".

As seen in Figure 1, the downstream utilization of the press-pulp and the type of replaced conventional

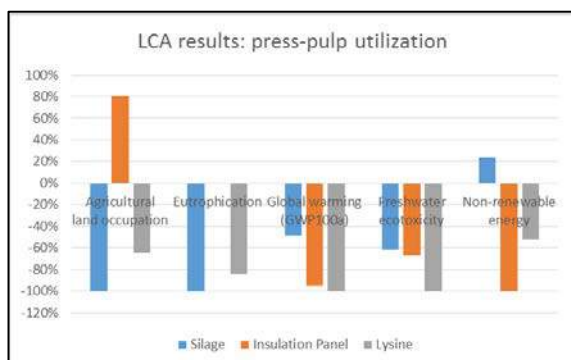

Figure 1: LCA results for the different utilization of the press-pulp. Results calculated for the conversion of 1ton_{DM} of biomass.

product has large effects on the environmental profile of the GBR. If the press-pulp is used to replace conventional energy-intensive materials (e.g. thermal insulation panels), there are large savings on energy related impact categories (ICs) such as Global Warming and Non-Renewable Energy use. If the replaced product is agricultural-based (e.g. silage or lysine), we can observe large savings on agricultural related ICs i.e. Agricultural Land Occupation and Eutrophication. Furthermore, while comparing the last two scenarios, the Lysine scenario has the best overall performance, suggesting that the production of high-value products leads to higher environmental savings.

Biorefining of green biomass can be technically possible and can bring environmental benefits compared to the conventional production. However, those benefits are largely dependent on the downstream utilization of the press-pulp, and consequently from the replaced conventional products.

References:

Kromus, S., Kamm, B., Kamm, M., Fowler, P., 2006. Green Biorefineries The Green Biorefinery Concept – Fundamentals and Potential.



Engineering *Lactococcus lactis* into a cell factory for production of butanol isomers

Joakim Mark Andersen*¹, Mette Dysseholm Mar¹, Vijayalakshmi Kandasamy², Jianming Liu¹, Theis Brock-Nannestad³, Christian Solem¹ and Peter Ruhdal Jensen¹

1: Microbial Biotechnology and Biorefining, DTU-FOOD. 2: DTU-Biosustain. 3: KU-Chemistry.

*Corresponding author email: joakm@food.dtu.dk

Butanol isomers are considered good fuel alternatives as well as valuable chemical building blocks, due to their high energy density, low hygroscopicity and comparable high reactivity. In this project, we explore the possibilities for biosynthesis of butanol isomers in *Lactococcus lactis* using metabolic engineering for expression of relevant heterologous pathways. The work is built upon a selection of *L. lactis* strains optimized for product formation through the pyruvate node, which has previously been used for achieving efficient production of a variety of bio-chemicals.

For a strain to be a proper candidate for second generation bio-refineries it should be highly efficient, robust with respect to withstanding high titers of products and inhibitors released during biomass pretreatment, and preferably be able to utilize both pentoses and hexoses simultaneously. Lactic acid bacteria have previously been identified as good candidates in general for bioconversion of lignocellulosic materials and show great tolerance to butanol and other alcohols. In this project, we focus on adapting and engineering *L. lactis* for solving these challenges.

Toward meaningful evaluation of climate change impacts in sustainability assessment of bioplastics

Serena Fabbri*¹, Mikolaj Owsianiak¹, Michael Zwicky Hauschild¹

1: Division for Quantitative Sustainability Assessment (QSA), DTU Management Engineering

*Corresponding author email: serf@dtu.dk

Assessing environmental sustainability of bio-based materials, such as bioplastics, plays a key role in supporting decision making in the transition towards a more resource-efficient and environmentally sound bio-based economy. Life Cycle Assessment (LCA) has been largely used to assess environmental impacts and benefits resulting from the entire life cycle of bioplastics and compare their environmental performance with conventional fossil-based plastics. Although the current methodology for assessing climate change impacts based on global warming potentials (GWP) is well established, there are some challenges when it comes to evaluate impacts of biopolymers. Based on these challenges, we propose three possible methodological improvements for better assessing climate change impacts of bioplastics. **First**, currently utilized and recommended methodologies do not consider the contribution of a greenhouse gas (GHG) emission to crossing of climatic tipping points, that is, levels of pressure on the climate system beyond which adverse and irreversible changes may occur. Bioplastics are sourced from biomass feedstocks and hence store atmospheric CO₂ which gives them the potential to mitigate climate change by delaying GHG emissions beyond the time when climatic tipping points are expected to be crossed. Earlier efforts to include a climatic target level into assessment of climate change impacts in LCA are limited to the climate tipping potential (CTP) indicator, which considers the tipping point related to melting of Arctic summer sea-ice, representing the cumulative contribution of a GHG emission to fill the remaining capacity left before reaching the predefined target level of atmospheric GHG concentration of 450 ppm CO₂ equivalents. However, impacts occurring after this target level is crossed are disregarded. We suggest to include other tipping points in the CTP method to allow quantifying the contribution of bioplastics to delaying exceeding of several critical levels. **Second**, the CTP method does not support modelling of the damage on human health and ecosystems resulting from climate change, such as loss of biodiversity. Accounting for impacts on these categories in the CTP methodology would be important to provide easily interpretable information on the actual damage caused if the use of bioplastics affects the crossing of climatic tipping points. **Finally**, including the effects of surface albedo changes on climate dynamics in the CTP indicator is relevant for bioplastics, as biomass farming for fermentation feedstock leads to changes in land use and surface reflectivity, which could cause significant perturbations of the Earth energy balance. We elaborate on the importance of these mechanisms and give recommendations for future research to better reflect climate change impacts in environmental sustainability assessment of bioplastics.

Lenton, T.M., Held, H., Kriegler, E., Hall, J.W., Lucht, W., Rahmstorf, S., Schellnhuber, H.J., 2008. Tipping elements in the Earth's climate system. *Proc. Natl. Acad. Sci.* 105, 1786–1793.

Jørgensen, S. V., Hauschild, M.Z., Nielsen, P.H., 2014. Assessment of urgent impacts of greenhouse gas emissions - The climate tipping potential (CTP). *Int. J. Life Cycle Assess.* 19, 919–930.

Evaluating Climate Change Mitigation Potential of Carbonaceous Materials: Do Different Indicators Point to the Same Conclusion?

Mikołaj Owsianiak*¹, Jennifer Brooks¹, Michael Renz², Alexis Laurent¹

1: DTU Management Engineering

2: Universitat Politècnica de València

*Corresponding author email: miow@dtu.dk

Life cycle assessment was employed to evaluate the use of hydrochars, prospective soil conditioners produced from biowaste using hydrothermal carbonization, as an approach to improving agriculture while using carbon present in the biowaste. In total, 17 categories of environmental impacts were considered, including three different indicators of climate change: global warming potential (GWP), global temperature change potential (GTP), and climate tipping potential (CTP) were used. It was found that although climate change benefits (GWP) from just sequestration and temporary storage of carbon were sufficient to outweigh impacts stemming from hydrochar production and transportation to the field, even greater benefits stem from replacing climate-inefficient biowaste management treatment options, like composting in Spain. By contrast, hydrochar addition to soil was not a good approach to improving agriculture in countries where incineration with energy recovery is the dominant treatment option for biowaste, like in Germany. Potential benefits from replacing composting were smaller in the GTP approach, which due to its long-term perspective gives less weight to short-lived greenhouse gases like methane. Using CTP as indicator, we also found that there is a risk of contributing to crossing of a short-term climatic target, the tipping point corresponding to an atmospheric GHG concentration of 450 ppm CO₂ equivalents, unless hydrochar stability in the soil is optimized. Our results highlight the need for considering complementary perspectives that different climate change indicators offer, and overall provide a foundation for assessing climate change mitigation potential of carbonaceous materials used in agriculture.

Owsianiak, M., Brooks, J., Renz, M., Laurent, A., 2017. Evaluating climate change mitigation potential of hydrochars: compounding insights from three different indicators. *GCB Bioenergy* 1–16.
doi:10.1111/gcbb.12484

Co-cultivation of Green Microalgae and Methanotrophic Bacteria for Single Cell Protein Production from Wastewater

Zahra Rasouli^{1,2}, Borja Valverde-Pérez^{1*}, Martina D'Este¹, Davide De Francisci¹, Irini Angelidaki^{1**}

¹Technical University of Denmark, Department of Environmental Engineering, Building 113, DK-2800 Kgs. Lyngby, Denmark (* bvape@env.dtu.dk; ** iria@env.dtu.dk)

²Ferdowsi University of Mashhad, Department of Agronomy and Breeding, Faculty of Agriculture Engineering, IranPlace your abstract here, add an image or two if possible and add references below.

Conventional water treatment technologies remove nutrients via resource intensive processes. However, new approaches for residual nutrient recycling are needed to provide food to the increasing world population. This work explores the use of microbial biomass – methane oxidizing bacteria and green microalgae – as a means to recover nutrients from industrial wastewater and upcycle them to feed grade single cell protein. Results demonstrated that both algae and bacteria could remove or assimilate most of the organic carbon present in the wastewater. However, their growth stopped before nutrients and substrates in the gas phase (i.e., methane and oxygen for methanotrophs and carbon dioxide for algae) were depleted. Likely, algal growth was light limited and stopped after organic carbon was consumed, whilst growth of methanotrophic bacteria could be limited by trace elements (e.g., copper). Nevertheless, the amino acid profile of both the monocultures and the algal-bacteria consortium was suitable for substitution of conventional protein sources. Further research should focus on increasing productivity of biomass grown on wastewater resources.

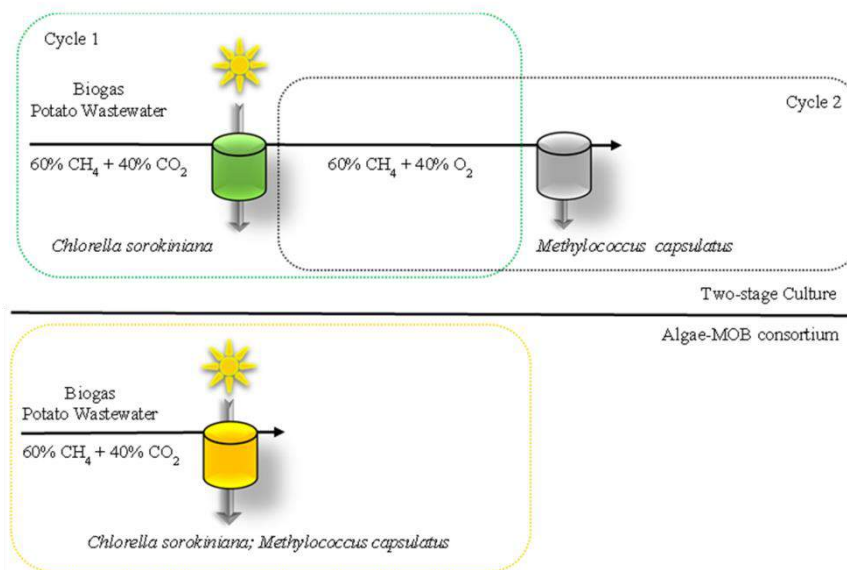

Figure 1. Schematic representation of the 2-stages process and 1-stage process.



Natural antioxidants derived from seaweed materials

Ditte B. Hermund^{1*}, Randi Neerup², Susan L. Holdt¹ & Charlotte Jacobsen¹

1: Division of Industrial Food Research, National Food Institute (DTU-FOOD), Technical University of Denmark, B 221, Søtofts Plads, DK-2800 Kgs. Lyngby, Denmark

2: Danish Technological Institute, Gregersensvej 1, DK-2630 Taastrup, Denmark

*Corresponding author email: dbala@food.dtu.dk

Natural antioxidants derived from seaweed have a high content of bioactive components with potential for improving oxidative stability of lipids in food or skin care products. Furthermore, some of these compounds can be used as functional ingredients in skin care products, e.g. against aging of the skin.

Seaweed cultivation is a rather new discipline in Denmark. Cultivation and utilization potential of brown algal *Saccharina latissima* are being studied in an ongoing research project (MAB4), for production of natural ingredients for the food, feed and cosmetic industry. As part of this project, different extraction solvents and conditions were used to study the solubility of different antioxidants, such as polyphenols, polysaccharides and carotenoids, from *S. latissima*. The extracts were screened by *in vitro* antioxidant assays and total phenolic content (TPC). The poster will contain the background and aim of the work and results on the antioxidant screening and TPC.



Memote - The genome-scale metabolic model test suite

Christian Lieven¹, [Moritz E. Beber](#)¹, Nikolaus Sonnenschein^{*1}

1: Novo Nordisk Foundation Center for Biosustainability, Technical University of Denmark

*Corresponding author email: niso@biosustain.dtu.dk

Genome-scale metabolic models (GEMs) have become fundamental and trusted tools in systems biology, facilitating *in silico* studies of metabolism across the entire spectrum of life. They are indispensable in the rational design and mechanistic understanding of cell factories at the level of metabolism. The availability of high quality GEMs is thus necessary for successful metabolic engineering projects.

As several studies have shown, neither the formal representation nor the functional requirements of GEMs are clearly defined. Without a consistent standard, reproducibility and interoperability of models between different groups and software tools cannot be guaranteed.

Here, we introduce memote (Metabolic Model Tests) a standardized testing suite for GEMs. Memote complements the *SBML Level 3 Flux Balance Constraints Package*, by providing a library of tests which enforce the standard model format. The suite also contains a host of functional checks on GEMs that go beyond the formal representation of a model. These tests cover all aspects of a metabolic model from syntactic conventions and annotations to conceptual and biological integrity. In addition, users can configure memote to use a range of experimental datasets for automated model validation.

Memote can act as a stand-alone benchmark of existing GEMs, or support *continuous* GEM reconstruction when integrated with successful software engineering practises such as web-based version control and continuous integration. A corresponding report displays the model's performance parameters for each change over time, driving informed model development and facilitating error detection.

Thus, memote not only allows researchers to more effectively iterate through the design-build-test cycle of the model reconstruction process, but also provides the scientific community with a measure of quality that is consistent across different operating systems, reconstruction platforms, and analysis software. Moreover, memote aims to simplify interaction and collaboration within the community by establishing workflows for publicly hosted and version controlled models.

Roles of extracellular polymeric substances in microbial extracellular electron transfer

Yong Xiao¹, Jens Ulstrup¹, Feng Zhao², Jingdong, Zhang^{1,*}

¹ Department of Chemistry, Technical University of Denmark, Kgs. Lyngby, Denmark

² CAS Key Laboratory of Urban Pollutant Conversion, Institute of Urban Environment, Chinese Academy of Sciences, Xiamen, China

(Presenting author: yongxi@kemi.dtu.dk; Corresponding author: jz@kemi.dtu.dk)

It is well known that microorganism is surrounded by extracellular polymeric substances (EPS) which include polysaccharides, proteins, glycoproteins, nucleic acids, phospholipids, and humic acids. However, previous studies on microbial extracellular electron transfer (EET) are conducted on cells without extracting EPS or cells collected from log stage or early-steady stage cultures with little EPS. Therefore, microbial cells are believed in contact directly with each other or electrode. Such attempt apparently ignored the role of EPS in microbial EET, even though many components of EPS, such as DNA, humic acids and some proteins, are electrochemically active or semiconductive. Herein, we report experimental evidences of EPS role on EET for *Shewanella oneidensis* MR-1.

Atomic force microscopy clearly showed that the cell surface was cleaned and few EPS could be observed on MR-1 after the extraction (Figure 1.a and 1.b). Comparing to cells in control group, MR-1 treated at 38 °C for EPS extraction showed different electrochemical characterizations as revealed by differential pulse voltammetry (Figure 1.c). EPS extracted from MR-1 also was proved to be electrochemically active. The present study indicated that EPS play important roles in EET of MR-1.

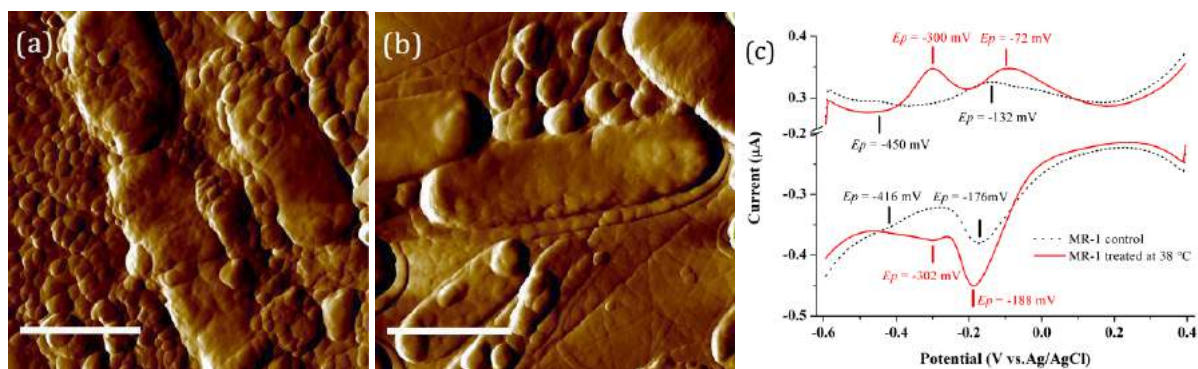

Figure 1 Atomic force microscopy shows more EPS surrounding the MR-1 cells in control groups treated 30 °C (a), comparing to those treated at 38 °C (b). Scale bar: 2 µm. Voltametric analysis of MR-1 treated at 30 °C (dotted line) and 38 °C (solid line) (c).

Acknowledgement: The study was supported by Carlsberg Foundation (CF15-0164).

References:

1. Yong Xiao, En-Hua Zhang, Jingdong Zhang, You-Fen Dai, Zhaohui Yang, Hans E. M. Christensen, Jens Ulstrup, Feng Zhao*. Extracellular polymeric substances are transient media for microbial extracellular electron transfer. *Science Advances*, 2017, 3(7): e1700623
2. Yong Xiao, Feng Zhao*. Electrochemical roles of extracellular polymeric substances in biofilms. *Current Opinion in Electrochemistry*, 2017, in press.

Biological systems for simultaneous methanation of CO₂ and H₂ by anaerobic microorganisms

Panagiotis G. Kougias*, Laura Treu, Irini Angelidaki

Department of Environmental Engineering, Technical University of Denmark, 2800, Kgs Lyngby, Denmark

*Corresponding author email: panak@env.dtu.dk

Biogas upgrading is an emerging technology for fuel production that can be used in transportation sector or substitute natural gas. Nowadays, the biological route for biogas upgrading via hydrogen assisted methanogenesis is gaining increased attention. The success of this process is strongly dependent on the applied environmental parameters (e.g. hydrogen partial pressure) and their subsequent influence on the microbial consortium (e.g. efficiency of syntrophic interactions). This abstract provides a collective synopsis of our previous studies on development of systems for biological upgrading of biogas with H₂. Two different concepts (in-situ and ex-situ biogas upgrading) were developed. For in-situ biogas upgrading, hydrogen was directly injected into the primary or secondary biogas reactor, and hydrogen could be converted to CH₄ together with CO₂ by autochthonous hydrogenotrophic methanogens. It was shown that after the H₂ addition, the CH₄ rate increased by 45%, resulting in an average CH₄ content of approximately 85%, with a maximum of 94%. The increase of the pH to 8.5, due to the CO₂ conversion, was not an inhibitory factor, demonstrating the adaptation of microorganisms to these pH levels. The profiles of the microbial communities prior and after the H₂ addition showed distinct differences. Changes in the archaeal community and more specifically increase in the relative abundance of *Methanobrevibacter* sp. and *Methanoculleus* sp. indicated that the methanogenic pathway was clearly shifted from acetoclastic to hydrogenotrophic. For ex-situ biogas upgrading, hydrogen and biogas were together injected into an anaerobic reactor containing enriched cultures that can convert H₂ and CO₂ to CH₄. Results demonstrated that the reactors were able to convert efficiently the injected H₂ and CO₂ to methane. More specifically, the final output content of CH₄ reached 96% at a hydrogen loading rate of 3.6 L/L_{reactor}·d H₂. During stable operational conditions, samples were collected from all reactors for microbial analysis based on high throughput 16S rRNA amplicon sequencing. The massive increase of hydrogenotrophic methanogens, such as *Methanothermobacter thermautotrophicus*, and syntrophic bacteria demonstrates the selection-effect of H₂ on community composition.

Enzyme discovery for tuber processing pulps

Kristian Barrett^{1*}, Anne Meyer¹ and Lene Lange¹

The full potential of agro-industrial side streams has not yet been unlocked of the massive production of tuber crops in China. The starch is extracted; however the remaining processing pulp hold potential unexploited value as animal feed among other applications. Due to too low dietary fiber nutritional content the pulp is undesired as a source of animal feed. To make the pulp more attractive for the farmer's, it is necessary to upgrade it. Increasing the protein content could make it more attractive; alternatively the complex polysaccharides could be converted into health promoting oligosaccharides by enzymatic hydrolysis of selected enzymes, but *where to look for such enzymes?*

The relevant enzymes are likely to be found in invasive microbes of the tuber crops in the field or in storage. If the candidates are reported as dangerous a closely related non-pathogenic and less dangerous species was selected.

China is the World's largest cultivator of sweet potato with in annual production of 72 million tons according to Food and Agriculture Organization of the United Nations, 2008. The accumulation of processing pulp is growing proportional to the production of starch from tuber crops involving increasing environmental stress and pollution. The starch to pulp ratio depends on the processing techniques but a general example of a local (low efficient) processing unity takes 30 tons of sweet potato pr.

day to generate about 25 tons of processing pulp and a starch yield of about 5 tons (Figure 1).

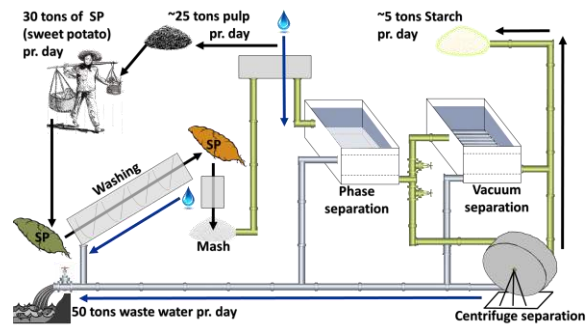

Figure 1 - Sweet potato processing - The farmer comes to the factory with harvested crops where the starch is extracted and the pulp is left for rotting or in some cases for animal feed with relatively low nutritional gain and contribution to growth.

To get an overview of which enzyme functions are present in different fungi, selected genome assemblies were screened for enzymes with carbohydrate acting activities upon genome, transcriptome and proteome sequencing. The selected fungi were investigated for interesting extracellular enzymes likely to cause degradation of tuber crops. Broth of the fungi indicated activities of several enzyme activities after growth of the fungi on media containing tuber processing pulp.



1: Department of Chemical and Biochemical Engineering
*Corresponding author email: kbaka@kt.dtu.dk



Having the End in Mind - The Pre-Pilot-Plant at DTU Biosustain

Andreas Worberg*¹, Yasin Yildiz Dastan¹, Severin Gregersen¹, Minkle Jain¹, Christopher Knudsen¹, Eleonora Pasutto¹, Milica Randelovic¹, Konstantin Schneider¹, Suresh Sudarsan¹, Jost Weber¹, Gossa Wordofa¹

¹: Novo Nordisk Foundation Center for Biosustainability, DTU Biosustain

*Corresponding author email: andwor@biosustain.dtu.dk

The Novo Nordisk Foundation (NNF) Center for Biosustainability (CFB) develops engineering workflows enabling the rapid, inexpensive construction of cell factories for a broad range of chemical and pharmaceutical products. While a cell factory alone has limited commercial value, combining the cell factory with a validated prototyped bioprocess creates a strong commercial value proposition, increasing the technology value by 3- to 10-fold by reducing the time and risk to market. Bio manufacturing plays a significant role in Danish industries and its economy by representing about 40% of the manufacturing output of the country. Thus, adding bioprocess development capabilities to the CFB would notably enhance its translational potential and socio-economic impact. A mid-term review carried out in the spring of 2015 resulted in a highly favorable report and a series of recommendations, including: 'the expert panel feels the ability to pursue top hosts at a pre-pilot/pilot-scale facility (PPP) will be an important step towards verification and subsequent potential commercialization of the assets developed at the CFB.'

NNF granted a substantial amount of money to establish such facility. The PPP is expected to be fully implemented by 2019 and the facilities are located on CFBs premises (Building 220). Operations start up by late of 2017, with a ramp up to full operation by end of 2018. Scientists, engineers and technicians will staff the facilities capable of developing two bioprocesses simultaneously while the first projects will commence in mid-2018 and equipment purchases and installation will be completed during 2017-19.

In order to productively invest PPP resources in accordance with CFB's mission (to promote a more sustainable bio based chemical industry), it is essential to rigorously evaluate technologies prior to entering the pre-piloting stage. Filter out those that are not commercially viable and/or are inconsistent with CFB's mission, give constructive guidance to those with commercial potential but not technically ready for pre-piloting. Prioritize those that are clearly ready for pre-piloting and have the most commercial potential and the greatest potential to fulfill CFB's mission. To characterize key process scale parameters the PPP has to operate at near, or at, planned operational system level to demonstrate at a small processing scale. Testing of industrial feeds (rather than research grade media), prototyping of product separation strategies, examination of impurities in the purified product, estimation of large-scale capital and operating costs, generation of kilogram quantity product samples is required to produce technology information packages for productive, fully-valued technology transfer into desired commercialization tracks (e.g. spin outs or licenses). Additionally the Center's facilities will provide process demonstrations, training, and troubleshooting support for internal and external stakeholders.

Insights on the activity of the anaerobic digestion microbiome by means of metatranscriptomic functional investigation

L. Treu¹, S. Campanaro^{2*}, A. Fontana^{1,3}, X. Zhu¹, P.G. Kougias¹ and I. Angelidaki¹

1: Department of Environmental Engineering, Technical University of Denmark, Kgs. Lyngby, DK-2800, Denmark

2: Department of Biology, University of Padova, Via U. Bassi 58/b, 35121 Padova, Italy

3: Department for Sustainable Food Process – DiSTAS, Catholic University of the Sacred Heart, 29122 Piacenza, Italy

*Corresponding author email: stefano.campanaro@unipd.it

Nowadays there is an urgent need of a sustainable solution for energy generation and waste resource recovery. Biogas production from Anaerobic Digestion (AD) of organic matter is an attractive technology that gained increasing attention as renewable source of energy. Anyway, the intricate set of microbial species that by their activity and abundance drives the AD process is far from being completely understood (Campanaro *et al.*, 2016). In order to produce high-value products, i.e. almost pure methane, the influence of operational parameters (e.g. temperature, pH, feedstock composition, etc.) on microbial activity needs to be addressed. A set of metatranscriptomic studies have been performed in replicate biogas reactors with the aim of correlating the microbial community structure and their changes in gene expression with the variations in process parameters. The first study investigated the transcriptional changes in a community after radical shifts of the influent feedstock determined by the addition of long chain fatty acids (LCFA). The importance of *Syntrophomonas* species was confirmed and the activation of chemotaxis genes was evidenced in several species; moreover an increased gene expression in *Methanosarcina* sp. was recorded (Treu *et al.*, 2016). Other two ongoing studies are focused on hydrogenotrophic methanogenesis and the role of syntrophic bacteria in the biogas production improvement obtained by the conversion of CO₂ into CH₄ via external hydrogen addition. Moreover, acetate accumulation and pH fluctuations were analyzed to identify the microbial key functions and correlate them with the disturbances affecting the AD process. Results shed light on the inhibitory conditions that can rise during the process, deciphering some of the metabolic pathways present in the species responsible for acetate production and accumulation.

References

Campanaro, S. *et al.* (2016) 'Metagenomic analysis and functional characterization of the biogas microbiome using high throughput shotgun sequencing and a novel binning strategy', *Biotechnology for Biofuels*, 9(1), p. 26. doi: 10.1186/s13068-016-0441-1.

Treu, L. *et al.* (2016) 'Untangling the Effect of Fatty Acid Addition at Species Level Revealed Different Transcriptional Responses of the Biogas Microbial Community Members', *Environmental Science and Technology*. Elsevier, 46(11), pp. 23–32. doi: 10.1021/acs.est.6b00296.

***In vitro* evaluation of the feed quality of enzyme treated bristles and hooves**

Yuhong Huang¹ et al (all names to be included before Sustain conference)

¹Department of Chemical and Biochemical Engineering, Technical University of Denmark, Building 229, 2800 Kgs. Lyngby, Denmark

Huge amounts of keratinaceous wastes such as feathers, hair and pig bristles are generated annually and cause a serious local disposal and accumulation problem. These keratinaceous wastes can be hydrolyzed by keratinolytic enzymes from fungi and bacteria and hereby converted into bioaccessible proteins, peptides and amino acids; products which can potentially be used to substitute significant portions of imported animal feed protein. In this study, we found an efficient bacterial keratin degrader, which can degrade chicken feather in 24 h. The total amino acid profile and content of the resulting hydrolyzed feed product was close to fish meal and soybean meal. The results suggest that conversion of keratinaceous waste might be a promising protein source for feed for fish and chicken.

Macroalgae-based biorefineries

Maria Dalgaard Mikkelsen, Nanna Rhein-Knudsen, Hang Thi Thuy Cao, Joseph Asankomah Bentil, Anders Thygesen, George E. Anasontzis, Anne S. Meyer, Lene Lange*

Center for BioProcess Engineering, DTU Chemical Engineering, Building 227, Technical University of Denmark, 2800 Kgs. Lyngby

*Corresponding author: lenl@kt.dtu.dk

Macroalgae, and especially the cultivated ones, are a promising renewable feedstock that, when used in a biorefinery design, they can provide a wide range of chemicals and biomaterials for numerous applications, in the food, feed, health, cosmetics, and energy sectors.

In the Center for Bioprocess Engineering, we work on a wide range of technological approaches to allow us to take full advantage of the biotechnological potential of macroalgae. We optimize the extraction methodologies using enzyme technology and green chemistry, aiming at the development of products, such as macroalgae-based hydrocolloids for food and pharma, and tailor-made fucoidan and fucoidan oligosaccharides for medical applications. We also propose the use of macroalgae and the various biorefinery side-streams as substrates for the production of single-cell protein, for microbial conversion with improved food and feed quality, for the production of prebiotic food and feed with beneficial effect on the gut flora, and as growth enhancers that allow microorganisms to grow on recalcitrant substrates.

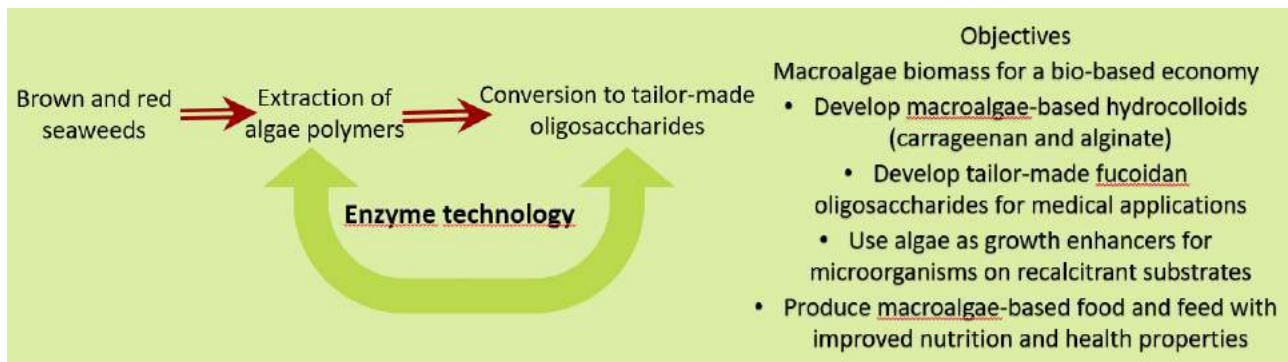

Session

S

Oral Presentations

See session details and schedule on
www.sustain.dtu.dk





Release the flexibility potentials by detoxifying the tax systems

Torben Funder-Kristensen, Head of Public and Industry Affairs, tfk@danfoss.com, Danfoss

This presentation outlines the potentials of utilizing the flexibility of vapor compression systems used for heat pumps and refrigeration in the context of the electrical and thermal energy grid. The success of introducing new flexible solutions depends on the economic viability. An overview of the potentials for exploiting the compressor capacity in supermarkets is given. The technical, environmental and economic potentials are described. Taxation procedures of the energy flows is seen to be a critical parameter for driving further development.

Session

S

Poster Presentations

See session details and schedule on
www.sustain.dtu.dk





A Dynamic Characterization of Energy Flexibility

R. G. Junker^{*1}, R. Relan¹, A. G. Azar¹, R. A. Lopes², H. Madsen¹

1: Technical University of Denmark, DTU Compute

2: Faculdade de Ciências e Tecnologia / Universidade Nova de Lisboa

*Corresponding author email: rung@dtu.dk

The large penetration rate of renewable energy sources leads to potential challenges in controlling the energy production. This necessitates moving from a paradigm of supply control to demand control for buildings and districts. To do so, a formal and robust characterization for the energy flexibility on the demand side is needed. The most common way to characterize the energy flexibility is by considering it as a static function at every time instant. The validity of this approach is questionable because energy based systems are never at steady-state. To account for this, we characterize the energy flexibility as a dynamic function. The dynamic characterization of energy flexibility allows a natural quantification of flexibility and enables the demand control through penalty signals (e.g. price, CO₂ etc.). Here, a test case study of indoor swimming pools is presented to show the advantages of characterizing the flexibility as a dynamic function over the static description.

skoleklima.dk – A platform to monitor air quality and thermal comfort in classrooms, developed for teachers and students

Davide Cali¹, Magnus Bachalarz¹, Peder Bacher¹, Henrik Madsen¹, Simon Westergaard Lex², Morten Koed Rasmussen³

1: DTU Compute, 2 University of Copenhagen, 3 Høje Taastrup Kommune - *Cor. author email: dcal@dtu.dk

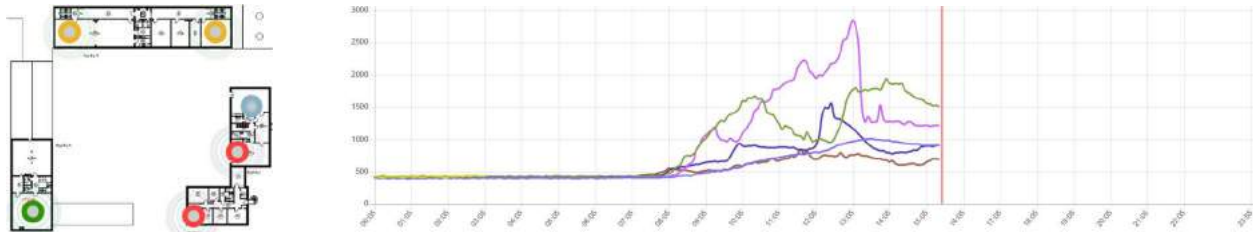

Figure 1 Qualitative evaluation of the CO₂ concentration (left) in some classrooms of a school, and related time series visualization (right) for a working day, from the skoleklima.dk platform.

Smart devices help us solving many complex tasks in an optimal way. In homes for instance, they can run our heating, ventilation and air conditioning systems (HVAC). Within the Smart Cities Accelerator project, among other goals, we aim to apply simple and cost effective smart solutions to get the best reachable indoor climate and thermal comfort at lowest energy cost, in real schools (located around the greater Copenhagen area, and the municipalities of Malmö and Lund in Sweden). Indoor air quality and thermal comfort are essential for a salubrious working and learning environment. We all well know that good thermal comfort conditions and a proper ventilation of the indoor environment lead to less sick leaves. Furthermore, we also know that a poor ventilated classroom exposes both teachers and scholars to high concentrations of volatile organic compounds (VOC) and CO₂. Some VOC can have both short and long terms effects on our health, hence their presence in the air should be minimize. Moreover, levels of CO₂ concentration above 1000 ppm negatively affect the performance of both scholars and teachers.

Over 100 classrooms located in three different schools of the Høje Taastrup Municipality have been equipped with wireless sensors. At time of writing, we collect air temperature, air relative humidity, noise level and CO₂ concentration at 5 minutes intervals. The air temperature and the relative humidity help us evaluating the thermal comfort in each classroom. Moreover, since only human beings (and eventually plants) emit CO₂ in classrooms, monitoring the CO₂ concentration allow us to estimate the air exchange rate of the room. We hence gain fundamental information about how to run optimally the HVAC system. Within the project, we will increase the number of sensors (including also heat meters) and add smart actuators (e.g. thermostatic valves) to get a better control over the HVAC, hence over the indoor climate and over the energy use. The platform skoleklima.dk offers scholars and teachers the opportunity to visualize own classrooms' data, and get a key for a qualitative interpretation of those measurements. We also provide them advices on how to address problems (e.g. when and how to optimally ventilate). In addition, through skoleklima.dk, scholars can run experiments to understand the physics behind the HVAC system and the indoor climate. Furthermore, skoleklima.dk offers the possibility to exchange information related to the indoor climate and the HVAC system between teachers, and between teachers and buildings' managers.

Heat Pumps for Efficient and Flexible Heat Supply in Copenhagen

Brian Elmegaard¹, Fabian Bühler¹, Jonas Kjær Jensen¹, Pernille Hartmund Jørgensen¹, Roberta Mancini¹, Wiebke Brix Markussen¹, Wiebke Meesenburg¹, Torben Ommen¹, Henrik Pieper¹, Erasmus Rothuizen¹, Benjamin Zühlsdorf¹

1: DTU Mechanical Engineering, Section Thermal Energy

*Corresponding author email: be@mek.dtu.dk

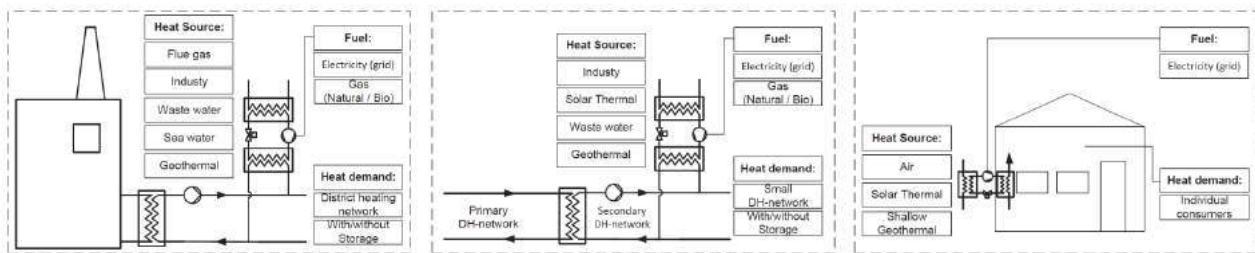

Danish society plans to be completely independent of fossil fuels in 2050. This will involve significant expansion of renewables, in particular wind and solar power, which implies that electric power may be the main energy carrier of the energy system. Copenhagen city's heat plan includes scenarios that will require up to 300 MW installed heat pump capacity. Such expansion will require considerable changes of the system which opens large potentials for innovative solutions both regarding dimensioning, design and operation of the installed heat pumps. In addition to supporting the electrification of the energy system, heat pumps are highly efficient and may support integration of excess heat, e.g., from industry, and benefit the electricity system by providing flexibility in terms of ancillary services for the electricity system.

In addition to the significant potentials heat pumps may provide, a large expansion of the technology also requires solution of a number of challenges. These include:

- Socio- and private economic competition with alternative technologies
- Access to low temperature heat sources at low cost both in terms of energy and capacity
- Development of component technology for the heat pumps, e.g. compressors
- Design, configuration and control of large-scale heat pump units with high Seasonal Coefficient of Performance, SCOP
- Access to appropriate refrigerants with low cost and environmental impact
- Integration in the existing district heating system by optimization of operating temperatures and utilization of heat storage
- Development of solutions with high flexibility in terms of load change for integration with the electricity system

The poster presents results of projects related to solving technical challenges for heat pump integration in Copenhagen's heat supply. The work is sponsored by the Danish Energy Agency's EUDP program and Innovation Fund Denmark.

Session

U

Oral Presentations

See session details and schedule on
www.sustain.dtu.dk



Quantifying shape, size, and composition distributions of nanoparticle aerosols by impaction and electron microscopy

Anders Brostrøm^{*1,2}, Kirsten Kling², Ismo K. Koponen², Kristian Mølhave¹

1: Technical University of Denmark, Department of Micro- and Nanotechnology, Ørsteds Plads, Building 345B, DK 2800 Kgs. Lyngby, Denmark

2: National Research Centre for the Working Environment, Lersø Parkallé 105, DK 2100 Copenhagen, Denmark

*Corresponding author email: abbl@dtu.dk

Air pollution has become a growing concern in the past few years and is now recognized as one of the major contributors to the global burden of disease, with particulate matter as one of its central concerns. Here nanoparticles, PM₁ and PM_{2.5} have been shown to pose the greatest risk due to their ability to penetrate deep into the lungs. Particles are released from a wide range of both natural and anthropogenic sources, where especially the transport sector is a major contributor. Simultaneously the use of nano materials in every day products is growing rapidly, bringing new exposure scenarios for both workers and users. As a result there is a need for exposure and risk assessments associated with the fabrication, use, and disposal of nano containing products, as well as in rural and general ambient environments. However, most of the current standard instruments bring no knowledge of particle composition or shape, which has recently been identified as crucial parameters in toxicological studies. New and additional measurement techniques are therefore needed to give a more detailed description of aerosol populations in order to establish standard procedures for measuring and regulating particulate exposure.

Here we present a procedure for sampling aerosol populations via impaction followed by automated software-based analysis using Scanning Electron Microscopy (SEM) and Scanning Transmission Electron Microscopy (STEM) coupled with Energy-Dispersive X-ray Spectroscopy (EDS). The automated analysis is capable of providing both detailed physical and chemical single particle information not provided by the current standard methods. Physical parameters such as area, diameter, and morphology is obtained, while automated EDS analysis is used to obtain elemental composition data, allowing size and morphology resolved chemical classification of each individual particle. The automated analysis is furthermore capable of systematically mapping large areas of a sample without user intervention, enabling fast and repeatable measurements, while obtaining sufficient data for statistical analysis.

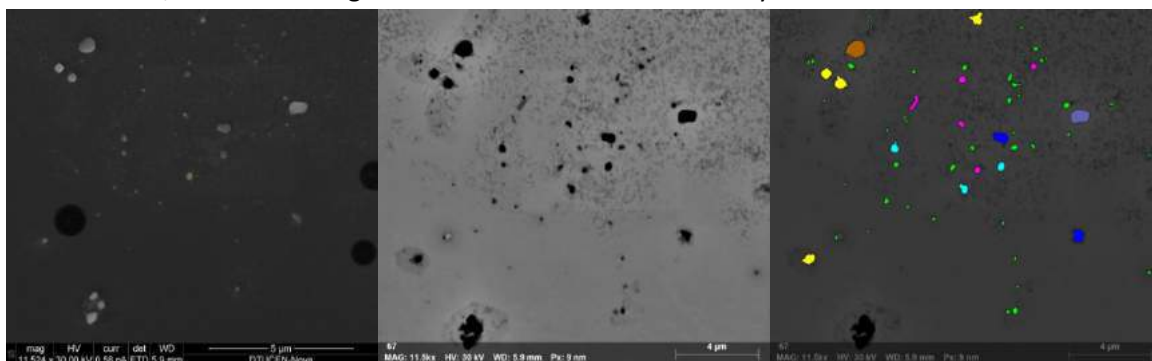

Figure 1. SEM images obtained from the automated analysis of an aerosol sample. Left: Secondary Electron (SE) image; Middle: Corresponding STEM image; Right: STEM image with particles marked for physical and elemental analysis.

Construction products in a more material circular world

J T Rørbech*

VELUX A/S, Ådalsvej 99, DK-2970 Hørsholm

*Corresponding author email: jakob.roerbech@velux.com



Demolished construction materials are the largest waste fraction in modern societies, making this a fraction an obvious targeted for circular economy initiatives at all levels from the European Commission over national waste regulation to the individual manufacture of construction products. Due to the diversity and long lifetime of most construction products, pollution and cross-contamination of different construction parts are challenging high value recovery and reutilization. Today's European construction product regulation are set up to facilitate the provision of safe products to the consumer primarily based on virgin materials.

In this presentation, I will give an overview of some of the regulatory limitations for secondary construction products and materials to enter the European market due to the existing system and legal responsibilities. Furthermore, I will give a brief overview of European standardization activities related to circular economy and sustainable chemicals. These activities are intended to 1) create a shared language regarding circularity of products and materials as well as providing measures by which circularity can be regulated, and 2) to investigate the need for standardization activities regarding the use of chemicals to enhance the circular economy. Finally, I will give examples on how VELUX are experimenting with different parts of the circular economy thinking through direct use of production waste, use of post-consumer waste and extended supplier collaboration.

“Recycled paper for food packaging: burden of disease methodology to link sustainability and safety“

Elena Boriani*^{1,2}, Eelco Pieke¹, Tine Hald¹, Sara Pires¹, Julie Boberg¹, Lea Sletting Jakobsen¹

¹ National Food Institute, Technical University of Denmark, Kgs. Lyngby, Denmark

² Global Decision Support Initiative, Technical University of Denmark, Kgs. Lyngby, Denmark

Corresponding author: Elena Boriani, email : ebor@food.dtu.dk

Background: Semi-quantitative analytical experimental studies¹ applied to recycled paper used as food contact materials have shown presence of endocrine –disrupting chemicals in pizza boxes made from recycled paper, and provided evidence that some of these chemicals will likely migrate from the packaging into the food. Therefore, the sustainability of recycling should be associated to safety because of the probable source of exposure to endocrine –disrupting chemicals from recycled food contact material which could lead to adverse health effects.

Purpose: The aim of this study is to estimate the burden of disease due to exposure to endocrine-disrupting chemicals present in food packaging and discuss the possible link between this study and a life cycle assessment of pizza boxes made from recycled paper. We consider, as example of endocrine-disrupting chemical, the high molecular weight phthalate DEHP (1,2-bis(2-ethylhexyl) benzene-1,2-dicarboxylate) from the consumption of commercially prepared (take-away) pizza in Denmark and estimate disease burden in terms of disability adjusted life years, DALYs^{1,2}.

Methodology: We applied a burden of disease model consisting of three submodules (Fig1).



Fig 1: The three modules of the burden of disease model

Expected outcomes: Our estimates will:

- Develop an approach to estimate the disease burden of endocrine-disrupting chemicals, filling in a knowledge gap at national and international levels.
- Allow for the integration of health impact assessment of a food contact material with the environmental impact and sustainability approach.
- Facilitate the evaluation and comparisons of different packaging alternatives by taking into account both human health and environmental impact of the material.

¹Pieke EN, Granby K, Trier X, Smedsgaard J. A framework to estimate concentrations of potentially unknown substances by semi-quantification in liquid chromatography electrospray ionization mass spectrometry, In *Analytica Chimica Acta*, Volume 975, 2017, Pages 30-41, ISSN 0003-2670,

²Poenaru D, Pemberton J, Frankfurter C et al (2013) Establishing disability weights for congenital paediatric surgical disease: a cross-sectional, multi-modal study. *Lancet* 381:S115, ³Salomon JA, Murray CJL. Estimating health state valuations using a multiple method protocol. In: *Summary Measures of Population Health Concepts, Ethics, Measurement and Applications*. Geneva: World Health Organization; 2002. p. 487–99.

Session

U

Poster Presentations

See session details and schedule on
www.sustain.dtu.dk



Risk governance framework for nanomaterials: Case studies and lessons

Ana Sofia Fonseca^{1,*}, Antti J. Koivisto¹, Ismo K. Koponen¹, Alexander C.Ø. Jensen¹, Kirsten I. Kling¹, Signe H. Nielsen¹, Keld A. Jensen¹

¹ National Research Centre for the Working Environment (NRCWE), Lerso Parkallé 105 DK-2100 Copenhagen, Denmark

* Corresponding author email: A. S. Fonseca (agf@nrcwe.dk)

Nowadays, risk assessment approach is inadequate to ensure a safe use and successful development of manufactured nanomaterials (MN) and MN-enabled products. None of the existing nano-specific control banding tools and quantitative models has been tested, calibrated and validated. The caLIBRAte Project (<http://www.nanocalibrate.eu/home>) aims to overcome this issue by developing a next generation “system-of-systems” for risk governance framework for assessment and management of human and environmental risks of MN and MN-enabled products. The framework will consist of tested and calibrated models and tools aligned to support decisions along the innovation stage-gates, from basic research to market launch.

This study highlights the state of the art initiatives in the field, as well as specific methodologies, tools and example models considered in the caLIBRAte Project. Different tools and models performance (covering Tier 1 by Stoffenmanager Nano v. 1.0; Tier 2 by NanoSafer v 1.1 and mass-balance 1-box and 2-box model; Hewett & Ganser 2017; Schneider et al. 2011; Zhang et al. 2009) were tested by comparing predicted inhalation exposure potentials with measured occupational exposure levels in a laboratory fume hood while pouring 700 g of CuO. Dustiness index (DI_m in mg kg^{-1}) for the specific powder CuO was characterized by using continuous drop dustiness test. The source emission rate (S_c in mg min^{-1}) was determined by taking into account the corresponding dustiness index, a handling energy factor and a localized control factor.

Results show that mass particle levels measured in near field (NF) were well predicted by the 2-box model (Table 1; $M_{NF, modeled} > M_{NF, real work environment}$). On the other hand, mass particle levels obtained by using 1-box model were underestimated 79% suggesting that the model was inadequate for this exposure scenario. To improve the predictability in modelling, workplace measurements with high quality conceptual information for model testing are needed.

Table 1. Modelled mass concentration during pouring 700 g CuO in a fume hood using the 1-box and 2-box model.

Pouring process under fume hood	DI_m [mg kg^{-1}]	S_c [mg min^{-1}]	$M_{NF, OPS}$ (0.3-10 μm) real work environment [$\mu\text{g m}^{-3}$]	2-box Model		1-box Model
				$M_{NF, modeled}$ [$\mu\text{g m}^{-3}$]	$M_{FF, modeled}$ [$\mu\text{g m}^{-3}$]	$M_{1-box, modeled}$ [$\mu\text{g m}^{-3}$]
700 g CuO	104	72.8	12.2	31.6	0.8	2.6

REFERENCES

- Hewett, P. & Ganser, G.H., 2017. Models for nearly every occasion: Part I - One box models. *Journal of Occupational and Environmental Hygiene*, 14(1), pp.49–57. Available at: <http://dx.doi.org/10.1080/15459624.2016.1213392>.
- Schneider, T. et al., 2011. Conceptual model for assessment of inhalation exposure to manufactured nanoparticles. *Journal of Exposure Science and Environmental Epidemiology*, 21(5), pp.450–463. Available at: <http://www.nature.com/doi/10.1038/jes.2011.4>.
- Zhang, Y. et al., 2009. Bayesian modeling of exposure and airflow using two-zone models. *Annals of Occupational Hygiene*, 53(4), pp.409–424.

Worker exposure during handling of manufactured nanomaterials in fume-hoods

Ana S. Fonseca^{1,*}, Eelco Kuijpers², Kirsten I. Kling¹, Marcus Levin¹, Antti J. Koivisto¹, Signe H. Nielsen¹, W. Fransman², Yuri F. Yu³, Ismo K. Koponen¹, Keld A. Jensen¹

¹ National Research Centre for the Working Environment (NRCWE), Lerso Parkallé 105 DK-2100 Copenhagen, Denmark

² TNO, Risk Analysis for Products in Development, Zeist, The Netherlands

³ PlasmaChem GmbH, Schwarzschildstr 10, 12489 Berlin, Germany

* Corresponding author email: A. S. Fonseca (agf@nrcwe.dk)

The earliest stage of manufactured nanomaterials (MNMs) exposure will likely occur in laboratories or pilot plants where activities of synthesis and handling MNMs in a dusty form are carried out (Ding et al. 2017). Fume-hoods are one of the most common types of emission controls applied to reduce the potential of particle exposure in laboratory environments (Balas et al. 2010). In this research the potential release and the workers' inhalation exposure associated with the synthesis and handling of CuO, ZnO and TiO₂ under a laboratory fume-hood was assessed. In order to increase confidence in worker protection by fume-hoods, the capacity of a fume-hood to prevent particle release to laboratory air during simulated spillage of three different MNMs (silica fume, zirconia TZ-3Y, and TiO₂) was evaluated by varying drop height and mass load.

Synthesis, handling and packaging of CuO, ZnO and TiO₂ nanoparticles did not result in detectable particle release to the laboratory air. Simulated powder spills showed a systematic increase in the particle concentrations inside the fume-hood with increasing amount of material and drop-height. Despite powder spills were sometimes observed to eject into the laboratory room, the spill events were rarely associated with notable increase in particle concentrations in front of the fume-hood (see Figure 1). Overall, this study confirmed an appropriate fume-hood with adequate sash height and face velocity prevents on average 98 % of particles release into the surrounding environment. Nevertheless, care should still be made to consider spills and high cleanliness to prevent exposure via resuspension and inadvertent exposure by secondary routes.

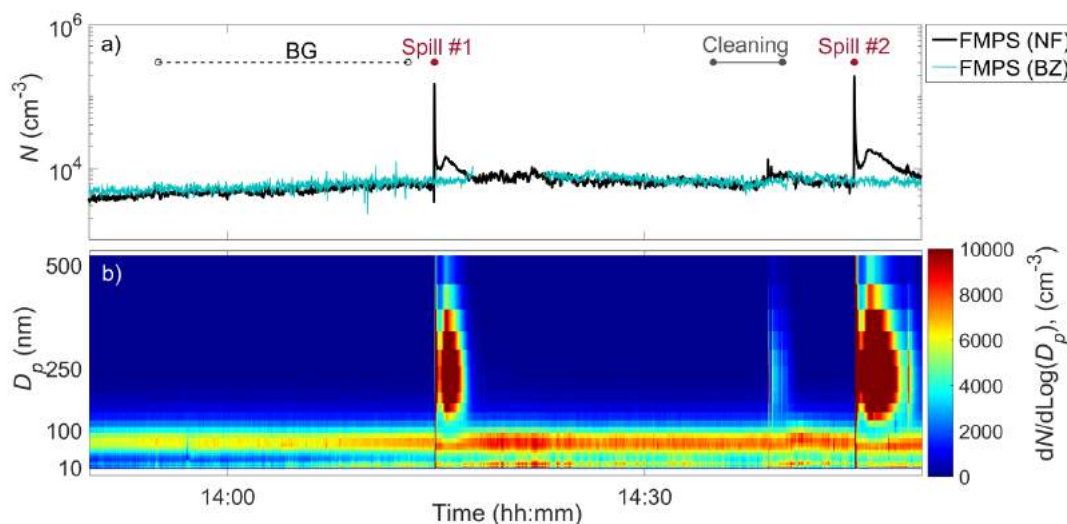

Figure 1 (a) Particle number concentration measured at near field (NF), and breathing zone (BZ) during spillage of 60 g of ultrafine TiO₂; (b) particle number size distribution measured in NF.

REFERENCES

- Balas, F. et al., 2010. Reported nanosafety practices in research laboratories worldwide. *Nature Nanotechnology*, 5(2), pp.93–96. Available at: <http://www.nature.com/doi/10.1038/nnano.2010.1>.
- Ding, Y. et al., 2017. Airborne engineered nanomaterials in the workplace???: a review of release and worker exposure during nanomaterial production and handling processes. *Journal of Hazardous Materials*, 322, pp.17–28.

Categorization of Advanced Materials and European Environmental Regulation

Steffen Foss Hansen^{*,1}, Florent Pelsy², Mark Broomfield³, Andrej Kobe⁴

¹) DTU Environment

²) Milieu Consulting

³) Ricardo Energy & Environment

⁴) European Commission DG Environment

*Corresponding author email: sfha@env.dtu.dk

Advanced engineering materials or just “advanced materials” is one of six technologies that have been identified as “Key Enabling Technologies” (KETs) by the European Commission. Here, we present one of the first efforts to systematically categorise, define and evaluate advanced materials in the context of their coverage by EU environmental legislation. Most of the categorisation schemes for advanced materials suggested in the literature provide a clear classification of the advanced material categories that they include although they differ substantially in regard to the number of included advanced material categories and the extent of coverage. A few schemes entail advanced material categories that are not defined or explained in any detail. In the context of regulatory coverage of advanced materials, it is particularly important to understand whether advanced materials or a specific category of advanced materials (e.g. nanomaterials and high-performance polymers) can be said to fall under definitions already set under EU legislation. For instance, the definition of polymers under REACH may not be adequate for high-performance polymers. A substantial effort is needed in order to ensure that definitions of advanced materials used in forthcoming research and regulation cover all relevant categories of advanced materials. Limited or no regulatory issues are foreseen if they do fall under existing definitions, whereas it is unclear how advanced materials will be regulated, if they do not fall under legislative definitions. Furthermore, a better overview is needed of the current annual manufacturing, production and commercialization of advanced materials in general and the different categories of advanced materials, to support regulation and an evaluation of environmental releases and potential risks. Further expert consultation and stakeholder engagement is needed in order to understand what the risks might be and how they might best be explored and handled.

References:

Broomfield, M., Hansen, S.F., Pelsy, F. 2017. Support for 3rd regulatory review of nanomaterials – environmental legislation. Brussels: European Commission.

Session

X

Oral Presentations

See session details and schedule on
www.sustain.dtu.dk



Supporting Sustainable Economic Growth in Greece through Pilot and Demonstration Projects

Jens Rønnow Lønholdt ¹

1: LYCEUM Innovation and Process Consultancy

*Corresponding author email: lonholdt@lyceumconsult.dk



It is an undeniable fact, that Greece is in dire need of economic growth, and it is our concern that this happens in a sustainable way. A joint group of researchers and business people from Denmark and Greece have cooperated on, and increasingly discussed the need for a more holistic and cross-cutting approach, based on the potential synergi between Greece and Denmark. By building a shared network there is basis for both knowledge sharing and collaboration on innovation and business development.

This initiative is conceptualised as the *Bright Green Greece* for sustainable growth covering environmental, economic and social sustainability. The first step has now been taken, as the area around Tolo in the Northern-Eastern Part of Peloponnes has been selected as the first project area. Based on both a solid business cooperation between Greece and Denmark, that has already been established and close links to academic environments with relevant resource center in both countries.

The first step will comprise a screening of the potential for sustainable growth, covering business, public services and infrastructure. A baseline will be established, and short and long term venues for instigating sustainable growth, will be identified and explored. Based on this a comprehensive plan of action will be developed. A decisive precondition for the above is, that a number of relevante private businesses will partake in the process, and that open cooperation can be established with the public sector. Private businesses will benefit from expertise within research based and innovative sustainable business development. The public sector will benefit from expertise within development of public services strategically as well as technically.

The above is proposed discussed, and hopefully a plan of action agreed upon, at a full-day Inception Workshop in Tolo, at the beginning of 2018.

Coastal Climate Risk Coping and Sustainable Development Goals for Cities

Kirsten Halsnæs, Professor, DTU Management Engineering, DTU Lyngby Campus, Building 426 a, 2800 Lyngby

khal@dtu.dk

The COHERENT project, funded by Innovation Fund Denmark, was instigated on Nov. 1 and addresses risks in the coastal zone of both natural and anthropogenic origin and the interplay between them. The project is highly multidisciplinary spanning natural, social and economic sciences as well as time scales from the immediate hazard response to longer term adaptation and management and with a high degree of cross-work package dependencies and coordination. This enables a 'COHERENT' approach in line with the session topic of 'regional transformations', where the relationship between risks from extreme climate change events and sustainable development goals of coastal areas and cities will be a major research and application area.

The presentation will introduce our methodological approach, where we combine quantitative assessment and modelling of physical flooding risks and social-science studies of damage costs, risk perception, technical adaptation measures, and social coping capacities. We will develop a new dynamic damage cost function methodology, and apply it to case studies of Danish coastal risks in the municipalities of Aabenraa, Ringkøbing-Skjern, and Skive as a basis for assessing how sustainable development goals in cities can be aligned with climate risk coping.



Rising Sea Levels – Seeking A Regional Response
Dr Glenn Frommer
gbachfrommer@gmail.com
International Sea Level Institute,
Copenhagen Office

Archaeological and scientific research has shown that changing temperatures of our planet results in changes to sea levels. The concentration of Green House Gases drives temperature change, in particular carbon dioxide, CO₂. Simply, high levels of CO₂, a warming planet result in rising sea levels.

We are currently measuring concentrations of CO₂ above 400 ppm, a level not seen in the past 800,000 years. IPCC scientists involved with climate prediction are forecasting sea level rise, with a potential worst case of up to 2.5m by 2100. We know that some exposed countries are already considering adaptation to a 1m rise in sea levels with particular protection of certain exposed areas. However, adaptation to the second meter of sea level rise in these areas is currently not being considered.

Preservation of our long-term economic well-being is significantly threatened in particular our maritime trade and the businesses and assets involved in that trade. Investing in our long-term future is vital, with earlier initiatives providing a significantly greater pay-back. Not only is a regional response essential, but there needs to be a transformation in how our professions collaborate and leverage off these fundamental challenges.

This paper will review and discuss the scientific evidence behind the multi-meter sea level rise prediction and some of the proposed adaptation initiatives.

Further, the paper will also present efforts of the International Sea Level Institute. The Institute's mission is to be the global leadership centre for understanding and adapting to the challenges of rising sea level and intends to establish three offices in North America, Copenhagen and the Far East. Further, the Institute aspires to become a catalyst for smart private and public-sector policies, explain the science behind sea level rise to millions around the globe, advance education across multiple professional disciplines and lead the way towards intelligent adaptation.

Recognizing the advanced awareness of professionals in the region, this paper will present initial thoughts for collaboration between the regional professions in adapting to sea level rise.

Sustainable climate adaption in a regional perspective

Eva Sara Rasmussen, Architect MAA MDL, Gottlieb Paludan Architects.

esr@gottliebpaludan.com

In Denmark, there has been a strong centralization of public institutions in the period after the turn of the millennium. In line with climate change, it has become increasingly necessary for sustainable development to be rooted and run in regional partnerships across geographical, professional and organizational boundaries. Partly to solve the actual climate adaptation, and partly to ensure anchoring and added value in the project in conjunction with the solution of other types of regional challenges.

The larger regional projects can, through the right professional, organizational and process management, more than local projects, lead to innovative, simple and clear solutions to issues that hitherto have been difficult to find a technically viable solution to, that matched the local economy. It is in the nature of the best regional projects that, in addition to technical and economic considerations, they must take care of wider nature and environmental interests, and that the solution must be good, sustainable and groundbreaking in a considerably longer timeframe.

The drivers in the process vary from place to place, but often contain one or more of the following economic, technical, environmental and social components:

- Depression, decline and shortened life expectancy.
- Technical challenges with climate adaptation, such as flooding and erosion or resource circuits.
- Loss of natural and man-made attractions.

The basis for creating lasting and sustainable changes is to insist on working holistically with the specific challenges seen in the light of the potential and potential of interdisciplinary synergies of the place and the project. The work towards creating sustainable regional solutions is the key overall goal:

- Identity and quality of life (the deeper change)
- Attraction and coherent stories about the place (vision),
- Joint project groups with technicians, citizens and stakeholders (dialogue and involvement),
- Scenarios for holistic technical solutions (solution catalog).

It is the hallmark of the best regional projects that the stronger the depth and breadth of both interdisciplinary and participating organizations, the stronger the outlook for sustainable results. In this regard, it is crucial that there are the right people and managers in the organization who have the right managerial and professional capacity to drive the projects credibly and purposefully. A regional network can eventually be established between the project's local staff to support the academic network.

Concrete examples of regional projects that have worked on the outlined approach: Land deployment project for the City of Copenhagen, implemented from 2016. Coastal and development project for the north coast of Zealand, completed from 2013. Klimatilpasning Kokkedal, pilot project in 2010-2011.

Sustainability labelling of climate mitigation actions relevant to Article 6 of the Paris Agreement

Karen Holm Olsen¹ and Fatemeh Bakhthiari²

1: Karen Holm Olsen (corresponding author), UNEP DTU Partnership, Department of Management Engineering, Technical University of Denmark, Marmorvej 51, 2100 Copenhagen Ø, Denmark, Telephone: +45 4533 5295, E-mail: kaol@dtu.dk

2: Fatemeh Bakhthiari, UNEP DTU Partnership, Department of Management Engineering, Technical University of Denmark, Marmorvej 51, 2100 Copenhagen Ø, Denmark, Telephone:+45 4533 5292, E-mail: fatebak@dtu.dk

Abstract:

The architecture of global carbon markets has fundamentally changed with the Paris Agreement and the 2030 Agenda for Sustainable Development Goals (SDGs) both agreed in 2015. Voluntary cooperative mechanisms are established in Article 6 of the Paris Agreement. In Article 6.4 a sustainable mitigation mechanism is established and rules modalities and procedures shall be developed internationally based on experience and lessons learned from existing mechanisms, such as the Clean Development Mechanism (CDM) and its Sustainable Development (SD) Tool. Historically the issue of integrated assessment of sustainable development and mitigation actions has been politically and methodologically controversial for many reasons: 1) Developing countries fear that an international definition of SD will interfere with their sovereignty to define their own development pathways; 2) carbon market players fear that markets can only handle one objective, namely mitigation outcomes; and 3) sustainable development is regarded as too complex and costly to be measured and quantified. In an effort to address these concerns, the paper proposes a new methodology for sustainability labelling of climate mitigation actions relevant to Article 6 mechanisms. The paper draws on an application of the CDM SD tool to analyse 2098 Component Programme Activities (CPAs) in the CDM Pipeline by January 2017. The paper suggests that assessment of sustainable development benefits of climate actions can be graded and labelled based on analysis of qualitative data, which is less costly than applying a quantitative approach.

Abstract for Sustain Conference, DTU Dec. 6th 2017

“Bornholm - regional transition through food production”

by Louise Groth-Michelsen and Lena Schenk, Regional Municipality of Bornholm, lgm@brk.dk

Facts about food production of Bornholm

Bornholm has 39.000 inhabitants and a farming area of 33.000 acres. In 2015 4,4 percent of this was organic cultivated (national average at 6,7 percent). The main farming areas and farmers are bound to a pig production to a local slaughterhouse. Besides this there are about 80 food producing companies. Half of these have sales platforms in all of Denmark and ¼ (20 companies) are also exporting. The Bornholm food sector accounts for 7-8 percent of the total added value in Bornholm. Including hotels and restaurants the number rises to 12 percent, which in 2015 reached 1.055 mio. kr. (2015). Bornholm has by 2017 one Michelin restaurant, 10 restaurants in the Whiteguide and 3 restauranter i Whiteguide Nordic.

Future challenges

Main challenges regarding the food sector is Bornholm facing a reduced number of both farms (they grow in size) and fishing boats.

The slaughter house is one of the major work places on the island. After the slaughter house a few years ago just avoided closing down, all relevant local partners still have a focus on keeping the slaughter house with its many local jobs on the island.

Besides this another challenge is Bornholm having a population with a general bad health profile and a both urgent and estimated future need of trained labor within the food industry, chefs and waiters etc.

Highlights concerned regional transition of Bornholm

- A strong local organization, cooperation and partnerships

Bornholm is well organized within the food sector, and the island is so to speak “small enough”: ideal for starting up new projects and to serve as a testbed for new initiatives. Bornholm depends on a symbiosis between small innovative and risk-minded undertakings and large consolidated companies with good market access. This makes the island an ideal foodstuffs testing ground. There is a strong in-island cooperation and a cluster between food producers and organizations. Local actors established the first Danish regional food culture house Madkulturhuset at Bornholm in 2014 connecting local food traditions, tourism and entrepreneurship. In general the food producers show big will of individual entrepreneurship and cooperation. Bornholm also takes part in Madfællesskabet.

- Common actions and local goals

In 2017 Bornholm launched a common food strategy created by a partnership consisting of the regional municipality, the farming organization and the organization of food producers.

The main food focus is connected to 2007 vision of Bright Green Island. In connection to this the municipality has a goal of 60 percent organic food in public meals supplemented with goals of 40 % locally food and 10% of food waste. Fueled by the success of saving the slaughter house a common will of creating a more diverse food sector and a multiplication of workplaces can also be traced.

Reference: Bornholms Fødevarestrategi 2017-2025,
<https://www.brk.dk/Erhverv/Landbrug/Sider/Landbrug.aspx>

Coastal communities and climate change – addressing needs for capacity building and collaboration

Carlo Sørensen*^{1,2}, Per Knudsen¹,

1: DTU Space 2: Danish Coastal Authority

*Corresponding author email: carlos@space.dtu.dk

Low-lying coastal communities face almost insurmountable challenges from climate change and sea level rise. As a natural consequence of their agglomeration of people and assets most research work focus on cities and mega-cities, whereas little attention is paid to the rather diverse range of local coastal communities and their tasks of climate change adaptation (CCA) and flood risk management (FRM). In Denmark, adaptation is mainly a local governance level responsibility however, and novel work forms need to be developed and utilized to compensate for a general lack of local expertise and knowledge. In order to mainstream climate change adaptation and risk reduction into management, planning and business and to reach sustainable and sound risk reduction measures, capacity building and collaboration across all levels of governance and sectors are necessary, respectively. A national level priority advocated for is a structured pathway to deal with CCA and FRM that e.g. builds on global frameworks like the Sendai Framework for Disaster Risk Reduction and the SDG's (Jebens and Sørensen, 2018). Additionally, community level actions must build on shared end-user defined needs which acknowledge location-specific challenges and the local actors. For this, capacity building through the set-up of collaborative and transdisciplinary networks to advance common agendas in local level adaptation work is suggested (Sørensen et al., 2018).

This paper presents research engagement in municipality led adaptation work carried out over the past three years regarding a highly vulnerable coastal community on the Danish North Sea coast. From this, perspectives of transdisciplinary work approaches are presented and discussed in relation to the recently initiated and DTU led COHERENT project (Coastal Hazard Risk Reduction and Management, 2017-2020) which is co-funded by the Innovation Fund Denmark 'Grand Solutions' scheme (<https://innovationsfonden.dk/da/presse/alle-kraefter-saettes-ind-bedre-kystbeskyttelse>), and the Central Denmark Region led C2C CC project (Coast to Coast Climate Challenge, 2017-2022), which is co-funded by the EU Life program (c2ccc.eu).

References

- Jebens, M. and Sørensen, C. (2018). Coping with Future Coastal Floods in Denmark - Advancing the use of Global Frameworks. In W. Leal Filho (Ed.), *Climate Change Impacts and Adaptation Strategies to Coastal Communities*. Climate Change Management Series. Berlin: Springer (In press).
- Sørensen, C.; Knudsen, P.; Sørensen, P.; Damgaard, T.; Mølgaard, M.R., and Jensen, J. (2018). Rethinking Coastal Community Approaches to Climate Change Impacts and Adaptation. Submitted to: Shim, J.-S.; Chun, I., and Lim, H.-S. (eds.), *Proceedings from the International Coastal Symposium (ICS) 2018* (Busan, Republic of Korea). *Journal of Coastal Research*, Special Issue No. 85.

Session

X

Poster Presentations

See session details and schedule on
www.sustain.dtu.dk



Title

“The accountability imperative for quantifying the uncertainty of emission forecasts: evidence from Mexico”

Authors

Daniel Puig (DTU), Oswaldo Morales-Nápoles (TUDelft), Fatemeh Bakhtiari (DTU), and Gissela Landa (OFCE)

Abstract

Governmental climate change mitigation targets are typically developed with the aid of forecasts of greenhouse-gas (GHG) emissions. The robustness and credibility of such forecasts depends, among other issues, on the extent to which forecasting approaches can reflect prevailing uncertainties. We apply a transparent and replicable method to quantify the uncertainty associated with projections of gross domestic product growth rates for Mexico, a key driver of GHG emissions in the country. We use those projections to produce probabilistic forecasts of GHG emissions for Mexico. We contrast our probabilistic forecasts with Mexico’s governmental deterministic forecasts. We show that, because they fail to reflect such key uncertainty, deterministic forecasts are ill-suited for use in target-setting processes. We argue that (i) guidelines should be agreed upon, to ensure that governmental forecasts meet certain minimum transparency and quality standards, and (ii) governments should be held accountable for the appropriateness of the forecasting approach applied to prepare governmental forecasts, especially when those forecasts are used to derive climate change mitigation targets.

POLICY INSIGHTS

- . No minimum transparency and quality standards exist to guide the development of GHG emission scenario forecasts, not even when these forecasts are used to set national climate change mitigation targets.
- . No accountability mechanisms appear to be in place at the national level to ensure that national governments rely on scientifically sound processes to develop GHG emission scenarios.
- . Using probabilistic forecasts to underpin emission reduction targets represents a scientifically sound option for reflecting in the target the uncertainty to which those forecasts are subject, thus increasing the validity of the target.
- . Setting up minimum transparency and quality standards, and holding governments accountable for their choice of forecasting methods could lead to more robust emission reduction targets nationally and, by extension, internationally.